

ORS CANADA

Most Popular Products

Volume 3



Mississauga: Phone 905-670-1223
Phone 800-745-2449 Fax 905-670-2875
cservice@orscanada.com

Calgary : Phone 403-243-8551
Phone 888-293-5606 Fax 403-243-8553
www.orscanada.com

Table of Contents

Industrial Section

3M	1
Anchor Cable Ties	3
Arrow	3
Automatic CH Hanson	3
Best Welds	4
Carborundum	4
Channellock	6
Chapin	6
Coxreels	7
CRC	8
Crescent	8
Devcon	9
Dewalt	10
Duracell	11
Dykem	11
Eclipse	12
Empire	16
Evolution	16
Garant	16
Genpack	16
Justrite	17
Kennedy	18
Klein Tools	18
Knipex	19
Loctite	19
LPS	21
Lubriplate	23
Lufkin	24
Lumax	25
Master Lock	26
Mattech	27
Markal	28
Metabo	29
Milwaukee	30
Motor Guard	30
Nissen	31
Norton	31
OLFA	32
Onguard	33
Pelican	33
Proto	34
Reelcraft	34
Ridgid	35
Rustoleum	37
Scrubs	38
Shurtape	39
SpilKleen	39

Industrial Section

Stanley	40
Streamlight	40
Sumner	41
Ullman	41
WD-40	41
Weiler	42
Werner	43
Wera	43
Wilton	44
Safety Section	
3M	45
3M – Capital Safety	49
Ansell	51
Comfort	52
Crews (MCR)	52
Degil	52
Dupont	54
Dynamic	56
Ergodyne	57
Fendall	58
Haws	59
Howard Leight	60
Jackson Safety	60
Kidde	61
Kimberly Clark	61
MCR	62
Mechanix Wear	62
Miller	63
Moldex	64
MSA	65
Norguard	66
North Safety	67
Pyramex	68
Ronco	68
Uvex	69
Vizcon	70
Westchester	71
Zoll	71
Welding Section	
3M - Speedglas	72
Anthony Carts	74
Arc One	74
Atlas	74
Bernard	75
Best Welds	75

Welding Section

Caiman	79
Cantesco	80
Century Wire	81
Comeaux Caps	81
Jackson Contour	81
Cooper	82
Cylinders	82
Fibre-Metal	83
Flange Wizard	86
Fuller(Shurlite)	87
General Cable	87
Goss	87
Harris	87
H&M Pipe	88
Jackson Safety	88
Magswitch	90
Magnaflux	91
Oetiker	92
Optrel	92
Parweld	92
Pearson	94
Phoenix	94
Pyramex	94
Rod Guard	95
Sellstrom	95
Tempil	95
Tweco	95
Victor	95
Weld Aid	96
Western	96
Wilson	97
Wypo	97
Janitorial Section	
Reckitt	100
3M	99
Cascades	99
Clorox	99
Pinesol	99
Tilex	99
Frost	99
Gojo	99
Permatex	100
Kimberly Clark	100
Proctor & Gamble	100
Reckitt Benckiser	100
Rubbermaid	100
SC Johnson	101
Simple Green	101
Sofidel	101
Unger	101



3M™ Cubitron™ II Fibre Disc



Part	Description
3MA051141-27400	Cubitron™ II Fibre Disc 982C, 4-1/2 in X 7/8 in 36+, 25/Inner 100/Case
3MA051141-27401	Cubitron™ II Fibre Disc, 982C, 5 in x 7/8 in, 36+ 25/Inner 100/Case
3MA051141-27402	Cubitron™ II Fibre Disc 982C 7in X 7/8 in 36+ 25/Inner 100/Case
3MA051141-27404	Cubitron™ II Fibre Disc 982C TN Quick Change 5 in 36+ 25/Inner 100/Case
3MA051141-27405	Cubitron™ II Fibre Disc 982C TN Quick Change, 7 in 36+, 25/Inner 100/Case
3MA051141-27632	Cubitron™ II Fibre Disc 982C, 5 In X 7/8 in 60+, 25/Inner 100/Case
3MA051141-27637	Cubitron™ II Fibre Disc 982C, 7 X 7/8 in 80, 25/Inner 100/Case
3MA051141-27448	Cubitron™ II Fibre Disc 987C, 5 In X 7/8 in 36+ 25/Inner 100/Case

3M™ Cubitron II Depressed Center Grinding Wheels



Part	Description
3MAAB78466Q	Cubitron™ II Depressed Center Grinding Wheel T27 4.5" x 1/4" x 7/8", 10/Box, 20/Case
3MA78467	Cubitron™ II Depressed Center Grinding Wheel T27, 5" x 1/4" x 7/8" , 10/Box, 20/Case
3MAAB64314Q	Cubitron™ II Depressed Center Grinding Wheel T27 6" x 1/4" x 7/8" , 10/Box, 20/ Case
3MA70-0011-8420	Cubitron™ II Depressed Center Grinding Wheel T27, 7" x 1/4" x 7/8", 10/Box, 20/Case

3M™ Cubitron II Flap Discs



Part	Description
3MA70-0014-8181	Cubitron™ II Flap Disc 967A, T27 4-1/2 in x 7/8 in 40+ Y-weight, 10/Case
3MA70-0014-8182	Cubitron™ II Flap Disc 967A, T27 4-1/2 in x 7/8 in 60+ Y-weight, 10/Case
3MA70-0014-8183	Cubitron™ II Flap Disc 967A, T27 4-1/2 in x 7/8 in 80+ Y-weight, 10/Case



3M™ Cubitron II Cut & Grind

Part	Description
3MA71-0001-9067	Cubitron™ II Cut And Grind T27 28758 6in 1/8in X 7/8 in 10/Inner 20/Case
3MA71-0001-9244	Cubitron™ II Cut And Grind T27 82278 5In 1/8in X 7/8in 10/Inner 20/Case



3M™ Cubitron II Cut-Off Wheel

Part	Description
3MA71-0002-3745	Cubitron™ II Cut-Off Wheel T27 66537 5 in X .045 in X 7/8 in 25 Per Inner 50/Case
3MA71-0002-4773	Cubitron™ II Cut-Off Wheel T1 66525 4.5 in X .045 in X 7/8In 25 Per Inner 50/Case

Scotch-Brite™ Roloc™ Surface Conditioning Disc



Part	Description
3MA07480	Scotch-Brite™ Roloc™ Surface Conditioning Disc, TR, A CRS, 07480, 2 in x NH 100/Case
3MASB07481	Scotch-Brite™ Roloc™ Surface Conditioning Disc, TR, A MED, 07481, 2 in x NH 100/Case
3MA07485	Scotch-Brite™ Roloc™ Surface Conditioning Disc, TR, A CRS, 07485, 3 in x NH 100/Case
3MASB07486	Scotch-Brite™ Roloc™ Surface Conditioning Disc, type A, MED, 07486, maroon, 3 in (7.62 cm) x NH 100/Case

3M™ Scotch Brite Hand Pads



Part	Description
3MASB7440B	Scotch-Brite™ Heavy Duty Hand Pad 40 Pads/Case
3MASB7447B	Scotch-Brite™ General Purpose Hand Pad 60Pads/Case



Part #	Description	Qty/Case	Part #	Description	Qty/Case
3MT101+12X55	101+ 12mm x 55m	72	3MT201+12X55	201+ 12mm x 55m	72
3MT101+18X55	101+ 18mm x 55m	48	3MT201+18X55	201+ 18mm x 55m	48
3MT101+48X55	101+ 48mm x 55m	24	3MT201+36X55	201+ 36mm x 55m	24
3MT301+18X55	301+ 18mm x 55m	48	3MT401+12X55	401+ 12mm x 55m	72
3MT301+24X55	301+ 24mm x 55m	36	3MT401+18X55	401+ 18mm x 55m	48
3MT301-36X55	301+ 36mm x 55m	24	3MT401+24X55	401+ 48mm x 55m	24



Part	Description
3MT26336	Scotch® Performance Masking Tape 233+, 24 mm x 55 m, 24 per case
3MT26340	Scotch® Performance Masking Tape 233+ ,48 mm x 55 m, 12 per case



3MT231-48X55
Scotch Masking Tape is a premium high-performance crepe paper masking tape designed to meet masking needs in most industrial painting situations, including the use of bake cycles

3MT2929-48X50
General Use Duct Tape 48mm X 50 Yards. Ideal product for conformable bundling, moisture resistance, and general repairs 24/Case

3MT3939-2X60
Duct Tape 3939 Silver, 2 in X 60 yard, 24/ Case Dependable and exceptional performance for repair and specialized applications

3MT369-48X100-CLEAR
3M™ Tartan™ Box Sealing Tape, 369, clear, 48 mm x 100 m, 36 per case. Adheres instantly to a variety of surfaces. Pressure-sensitive rubber adhesive offers a good, tight, general purpose seal



3MTSUPER33-3/4X66
Scotch® Super 33+™ Professional Grade Vinyl Electrical Tape, black, 7 mil (0.18 mm), 1-1/2 in x 108 ft (38 mm x 33 m). For indoor and outdoor applications. Excellent resistance to abrasion, moisture, alkalis, acids, corrosion and varying weather conditions



3MTSUPER88-3/4X66 Scotch® Premium Vinyl Electrical Tape Super 88, 3/4 in x 66 ft is a premium grade, 8.5-mil thick, all-weather vinyl insulating tape. It is designed to perform continuously between a temperature range of 0–220°F (-18–105°C). It has an excellent resistance to UV rays, abrasion, moisture, alkalis, acids, corrosion and varying weather conditions



3MTEMFLEX-3/4X60
3M™ Temflex™ General Use Vinyl Electrical Tape, 7 mil, 3/4 in x 60 ft is a good quality, economical general-purpose vinyl insulating tape. It has excellent resistance to abrasion, moisture, alkalis, acid, copper, corrosion and varying weather conditions



3MT77-24OZ-IND
Super 77™ Multipurpose Adhesive, 24 oz, 6 per case, Aerosol. High tack, high coverage and fast drying for permanently attaching foils, carpeting, lightweight foams, paper, cardboard, felt and, cloth to painted or unpainted metals, wood and hardboard



3MT8088-60X66
3M™ Construction Sheathing Tape, 8088, 60 mm x 66 m, 20 per case, individually wrapped. Installs and performs well over a broad temperature range. Excellent vapour barrier tape on polyethylene film



3MT8934-24X55
Filament Tape, 8934, clear, 24 mm x 55 m is constructed on a clear polypropylene backing, reinforced with glass yarn filaments, for strapping, bundling and reinforcing applications. It has a tensile strength of 100 pounds per inch width and the synthetic rubber resin adhesive offers good shear strength to fibreboard, plastics and most metals surfaces



3MT90-24OZ-IND
Hi-Strength 90 Spray Adhesive, clear, 24 oz. (709.77 mL). Finger touch, targeted control ensures minimal overspray, waste, and cleanup. Strong, permanent bond. High temperature resistance. Variable width lace spray pattern



Part	Description
102-418N	Anchor Cable tie 4.1" 18lb. Tensile - Natural - 100/bag
102-418UVB	Anchor Cable tie 4.1" 18lb. Tensile - UV Black - 100/bag
102-750N	Anchor Cable tie 7.6" 50lb. Tensile - Natural - 100/bag
102-750UVB	Anchor Cable tie 7.6" 50lb. Tensile - UV Black - 100/bag
102-1150N	Anchor Cable tie 11.1" 50lb. Tensile - Natural - 100/bag
102-1150UVB	Anchor Cable tie 11.1" 50lb. Tensile - UV Black - 100/bag
102-1450N	Anchor Cable tie 14.6" 50lb. Tensile - Natural - 100/bag
102-1450UVB	Anchor Cable tie 14.6" 50lb. Tensile - UV Black - 100/bag
102-15120N	Anchor Cable tie 15" 120lb. Tensile - Natural - 50/bag
102-15120UVB	Anchor Cable tie 15" 120lb. Tensile - UV Black - 50/bag
102-24175N	Anchor Cable tie 24.5" 175lb. Tensile - Natural - 50/bag
102-24175UVB	Anchor Cable tie 24.5" 175lb. Tensile - UV Black - 50/bag
102-36175N	Anchor Cable tie 36" 175lb. Tensile - Natural - 50/bag
102-36175UVB	Anchor Cable tie 36" 175lb. Tensile - UV Black - 50/bag



091-T50
Heavy duty
staple gun
tacker



091-T50ACD
Electric DIY
staple gun



091-P22
Plier-type
stapler



091-TR550
Professional
trigger feed
glue gun



091-256
T25 3/8"
staples
1000/Pack



091-257
T25 7/16"
staples
1000/Pack



091-50424
T50 1/4"
staples
1250/Pack



091-50524
T50 5/16"
staples
1250/Pack



091-HT50-10
Heavy duty
hammer
tacker



091-T25
Low voltage
wire staple
gun tacker



091-SS6
4" slow set
glue sticks
6/Pack



091-224
P22 1/4"
staples
5000/Pack



Automatically locks on without adjusting Ergonomically shaped handle Set & Forget™, Set desired pressure, from slight to extreme and jaws automatically adjust to any size with equal grip pressure



Part	Description	Part	Description
AUT06100	6 in Curved Jaw	AUT10100	6 in Curved Jaw
AUT06200	7 in C Clamp	AUT10200	7 in C Clamp
AUT06201	7 in C Clamp Swivel Pads	AUT10201	7 in C Clamp Swivel Pads
AUT09300	7 in Needle Nose	AUT09300	7 in Needle Nose



Bestwelds Brushes

Part	Description
OKIBW103	Long Handle Brush 3 X 19
OKIBW104	Long Handle Brush 4 X 18
OKIBW112	Shoe Handle Brush 4 X 16
OKIBW190	Inspect Brush 3 X 7 Stainless Steel
OKIBW9103	Long Handle Brush 3 X 19 Stainless Steel
OKIBW9104	Long Handle Brush 4 X 18 Stainless Steel
OKIBW9112	Shoe Handle Brush 4 X 16 Stainless Steel

Weld-ON Hinges

Part	Description
BWSWGF.FES.080	FES 080GF With Grease Fitting 3 3/16 (80 mm) 25/box
BWSWGF.FES.100	FES100GF With Grease Fitting 4 (100 mm) 25/box
BWSWGF.FES.150	FES150GF With Grease Fitting 6 (150 mm) 25/box
BWSWGF.FES.200	FES 200GF With Grease Fitting 8 (200 mm) 25/box
BWSWSP.FES.060	FES 060 Fixed Steel Pin 2 3/8 (60 mm) 25/box
BWSWSP.FES.080	FES 080 Fixed Steel Pin 3 3/16 (80 mm) 25/box
BWSWSP.FES.100	FES100 Fixed Steel Pin 4 (100 mm) 25/box
BWSWSP.FES.150	FES150 Fixed Steel Pin 6 (150 mm) 25/box
BWSWSP.FES.200	FES 200 Fixed Steel Pin 8 (200 mm) 25/box



PREMIER RED Depressed Center Wheels Better Tier / Zirconia Alumina

Outstanding results grinding stainless steel, high alloy steel, and all ferrous metals

Part	Description	Spec and Size	Pack Size
481-05539502870	PREMIER RED STAINLESS	ZA30T-4-1/2"X.125"X7/8"-T27	20
481-05539502872	PREMIER RED	ZA24Q-4-1/2"X1/4"X7/8"-T27	20
481-05539502874	PREMIER RED STAINLESS	ZA30T-5"X.125"X7/8"-T27	20
481-05539502876	PREMIER RED	ZA24Q-5"X1/4"X7/8"-T27	20
481-05539502881	PREMIER RED	ZA20Q-7"X1/4"X7/8"-T27	20



CARBO GOLD Depressed Center Wheels Good Tier / Aluminum Oxide

For Grinding Stainless Steel

Part	Description	Spec and Size	Pack Size
481-05539570191	GOLD MAXX	ZA30-4-1/2 x 1/4 x 7/8 T27	20
481-05539570193	GOLD MAXX	ZA30-5"X1/4"X7/8"-T27 INOX	20
481-05539570194	GOLD MAXX	ZA30-7 x 1/4 x 7/8 T27	20



CARBO GOLD Small Diameter Reinforced Cut-off Wheels Good Tier / Aluminum Oxide

For cutting off ferrous metals, alloy steels and cast iron.

Part	Description	Spec and Size	Pack Size
481-05539509268	GOLD	A60O-3"X.035"X3/8"-T01	25
481-05539509263	GOLD	A36T-3"X1/16"X3/8"-T01	25
481-05539561551	GOLD TYPE 27	A30T-4-1/2"x 045"x7/8"-T27	20
481-05539561553	GOLD TYPE 27	A30T-5"X.045"X7/8"-T27	20



CARBO GOLD Cut Right Angle Grinder Reinforced Cut-off Good Tier / Aluminum Oxide

For general purpose cutting of stainless steel, steel and metal material with a right angle grinder

Part	Description	Spec and Size	Pack Size
481-05539563952	GOLDCUT	A60Q-4-1/2"X.045"X7/8"-T01	25
481-05539563953	GOLDCUT	A60Q-5"X.045"X7/8"-T01	25
481-05539563954	GOLDCUT	A60Q-6"X.045"X7/8"-T01	25

PREMIER RED Paper Sheets Best Tier / Aluminum Oxide Dri-Lube Resin Paper Open

Ultimate choice for machine and hand sanding of paints, primers, light metals and basecoat/clearcoat paints.

Part	Description	Spec and Size	Pack Size
481-05539520538	PREMIER RED	SHS SST 9"x11" B0912DO P80	50
481-05539520530	PREMIER RED	SHS SST 9"x11" B0912DO P320	100
481-05539520531	PREMIER RED	SHS SST 9"x11" B0912DO P280	100
481-05539520532	PREMIER RED	SHS SST 9"x11" B0912DO P240	100
481-05539520533	PREMIER RED	SHS SST 9"x11" B0912DO P220	100
481-05539520534	PREMIER RED	SHS SST 9"x11" B0912DO P180	100
481-05539520535	PREMIER RED	SHS SST 9"x11" B0912DO P150	100
481-05539520536	PREMIER RED	SHS SST 9"x11" B0912DO P120	100
481-05539520537	PREMIER RED	SHS SST 9"x11" B0912DO P100	100

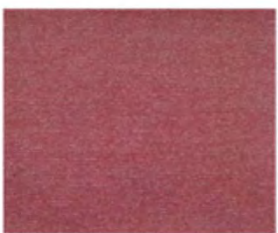



CARBORUNDUM

ALUMINUM OXIDE Cloth Rolls Good Tier / Aluminum Oxide Resin Cloth

Ideal for cleaning and deburring metal surfaces. May be used dry or with oil.

- Tough and durable • Exceptional grain adhesion for longer life
- Superior conformability to complex surfaces and better finishes
- Convenience; cut or tear to length

Part	Description	Spec and Size	Pack Size
481-05539529350	Carbo	RTH RHR 2"x50YD JCF0852 P80	1
481-05539529344	Carbo	RTH RHR 2"x50YD JCF0852 P240	1
481-05539529346	Carbo	RTH RHR 2"x50YD JCF0852 P180	1
481-05539529348	Carbo	RTH RHR 2"x50YD JCF0852 P120	1
481-05539529349	Carbo	RTH RHR 2"x50YD JCF0852 P100	1
481-05539529328	Carbo	RTH RHR 1"x50YD JCF0852 P80	1
481-05539529322	Carbo	RTH RHR 1"x50YD JCF0852 P240	1
481-05539529323	Carbo	RTH RHR 1"x50YD JCF0852 P220	1
481-05539529324	Carbo	RTH RHR 1"x50YD JCF0852 P180	1
481-05539529326	Carbo	RTH RHR 1"x50YD JCF0852 P120	1
481-05539529327	Carbo	RTH RHR 1"x50YD JCF0852 P100	1

POWERLOCK CLOTH DISCS – ZIRC PLUS R801 Ideal product for demanding grinding applications. Grinding aid results in cooler cut on stainless steel, titanium and other exotic alloy

Part	Description	SOA	Spec and Size
481-08834167069	Merit	Coated	SPE ZMD 2" R801 C80 Y
481-08834167109	Merit	Coated	SPE ZMD 2" R801 C50 Y
481-08834167107	Merit	Coated	SPE ZMD 2" R801 C36 Y

ZIRCONIA ALUMINA RESIN FIBRE DISCS Durable zirconia alumina abrasive with a heavy fiber backing, this disc is a great performer on stainless steel

Part	Description	Spec and Size	Pack Size
NTN66623353319	Merit	DFI DI 4-1/2"x7/8" FX672 MER C60	25
NTN66623353316	Merit	DFI DI 4-1/2"x7/8" FX672 MER C36	25
NTN66623357293	Merit	DFI DI 5"x7/8" FX672 MER C60	25
NTN66623357291	Merit	DFI DI 5"x7/8" FX672 MER C36	25
NTN66623357290	Merit	DFI DI 5"x7/8" FX672 MER C24	25

Premier red Paper Sheets Best Tier / Aluminum Oxide Dri-Lube Resin Paper Open

Best choice for sanding all paints, primers, plastics and fiberglass. Also suited for sealer and wash coats in wood furniture

- 30% to 50% faster cut rate than other discs • Consistent scratch pattern and finish
- Improved grain adhesion and longest disc life • Easy application and removal
- Superior load resistance and extended life • No color transfer to work

Part	Description	Spec and Size	Pack Size
481-05539518173	PREMIER RED	DRO DIR 6"x0"x100 B0912DO P80 PSAU+	4
481-05539518165	PREMIER RED	DRO DIR 6"x0"x100 B0912DO P320 PSAU+	4
481-05539518166	PREMIER RED	DRO DIR 6"x0"x100 B0912DO P280 PSAU+	4
481-05539518167	PREMIER RED	DRO DIR 6"x0"x100 B0912DO P240 PSAU+	4
481-05539518168	PREMIER RED	DRO DIR 6"x0"x100 B0912DO P220 PSAU+	4
481-05539518169	PREMIER RED	DRO DIR 6"x0"x100 B0912DO P180 PSAU+	4
481-05539518170	PREMIER RED	DRO DIR 6"x0"x100 B0912DO P150 PSAU+	4
481-05539518171	PREMIER RED	DRO DIR 6"x0"x100 B0912DO P120 PSAU+	4
481-05539518172	PREMIER RED	DRO DIR 6"x0"x100 B0912DO P100 PSAU+	4
481-05539518114	PREMIER RED	DRO DIR 5"x0"x100 B0912DO P80 PSAU+	4
481-05539518106	PREMIER RED	DRO DIR 5"x0"x100 B0912DO P320 PSAU+	4
481-05539518107	PREMIER RED	DRO DIR 5"x0"x100 B0912DO P280 PSAU+	4
481-05539518108	PREMIER RED	DRO DIR 5"x0"x100 B0912DO P240 PSAU+	4
481-05539518109	PREMIER RED	DRO DIR 5"x0"x100 B0912DO P220 PSAU+	4
481-05539518110	PREMIER RED	DRO DIR 5"x0"x100 B0912DO P180 PSAU+	4
481-05539518111	PREMIER RED	DRO DIR 5"x0"x100 B0912DO P150 PSAU+	4
481-05539518112	PREMIER RED	DRO DIR 5"x0"x100 B0912DO P120 PSAU+	4
481-05539518113	PREMIER RED	DRO DIR 5"x0"x100 B0912DO P100 PSAU+	4



The CHANNELLOCK® Straight Jaw Tongue and Groove Plier is the tool every home and garage needs. This plier is built to last with a PermaLock® fastener to eliminate nut and bolt failure, patented reinforcing edge to minimize stress breakage and right angle, laser heat-treated teeth to provide a better, longer lasting grip.



Part	Description
140-420	9.5" Straight Jaw Tongue & Groove Plier
140-426	6.5" Straight Jaw Tongue & Groove Plier
140-430	10" Straight Jaw Tongue & Groove Plier
140-440	12" Straight Jaw Tongue & Groove Plier

A unique jaw design creates more points of contact on round stock and tubing. This creates a stronger bite and more control - all with the legendary strength of a CHANNELLOCK® Tongue and Groove Plier.



Part	Description
140-412	6.5" V-Jaw Tongue & Groove Plier
140-422	9.5" V-Jaw Tongue & Groove Plier
140-432	10" V-Jaw Tongue & Groove Plier
140-442	12" V-Jaw Tongue & Groove Plier



140-957
7" Wire Stripper
Electricians demand precision and reliability. That's why they choose CHANNELLOCK® Wire Strippers



140-447
8" High Leverage Curved Diagonal Lap Joint Cutting Plier. Cutting capabilities include piano wire (0.056" min diameter - 0.091" max diameter), hard wire (0.047" - 0.091"), medium hard wire (0.047" - 0.091") and soft wire (0.162" max diameter)



139-80088A
Assembled Salt / Ice Melt Halite Spreader.
U-Shaped Handle
With Ambidextrous Bail,
Powder Coated Steel Frame
12" Pneumatic Tires
Adjustable Gate Dial
on Hopper Base.
Grate & Rain Cover
Included
80LB Residential



139-82108B
Partially Assembled Salt / Ice Melt / Halite Spreader.
Enclosed Metal Gears
Adjustable Slide Gate,
Stainless Steel T-Handle
With Rubber Grips
Stainless Steel Frame
Wide Tread 14" Pneumatic Tires
Adjustable Front and Side Baffles
Grate & Rain Cover Included
80LB Professional



139-1046
48-Ounce Industrial Cleaner/Degreaser Hand Sprayer
48-ounce translucent poly bottle
Compatible with most industrial chemicals, suitable for homeowners too (check chemical manufacturers instructions) adjustable cone nozzle and shut-off In-tank anti-clog filter



139-22350XP
2 Gal. Ind. (XP) Viton Cleaner/Degreaser.
Designed specifically for industrial strength cleaners and degreasers
Viton seals and gaskets to handle a variety of chemicals. Adjustable poly cone nozzle sprays coarse stream to a fine mist



COXREELS® P Series "Performance" spring driven hose reels have a long history of dependability and trouble free performance. Their compact space-saving size and heavy duty construction make them highly versatile and virtually indestructible.

Model	I.D	O.D	Length
170-P-LP-125	1/4"	1/2"	25'
170-P-LP-325	3/8"	5/8"	25'
170-P-LP-350	3/8"	5/8"	50'
170-P-LP-450	1/2"	3/4"	50'



COXREELS® P Series "Performance" spring driven hose reels have a long history of dependability and trouble free performance. Their compact space-saving size and heavy duty construction make them highly versatile and virtually indestructible.

Model	I.D	O.D	Length
170-EZ-P-LP-125	1/4"	1/2"	25'
170-EZ-P-LP-325	3/8"	5/8"	25'
170-EZ-P-LP-350	3/8"	5/8"	50'
170-EZ-P-LP-450	1/2"	3/4"	50'



COXREELS® SH Series "Super Hub™" spring driven hose reels, like the P Series, have a long history of dependable performance. The larger chassis and frame accommodate longer lengths and larger diameters of hose. Coxreels' original Super Hub™ dual axle support system increases the stability during operation, reduces vibration and strengthens the structural integrity of the reel.

Model	I.D	O.D	Length
170-SH-N-125	1/4"	1/2"	25'
170-SH-N-325	3/8"	5/8"	25'
170-SH-N-350	3/8"	5/8"	50'
170-SH-N-450	1/2"	3/4"	50'



COXREELS® T Series "Truck Mount" spring driven hose reels are the toughest hose reels in the spring driven line. The extra large chassis with dual pedestal-style arms and Coxreels' Super Hub™ provides triple axle support while reducing vibration and strengthening the structural integrity of the reel. Making it perfect for off-road applications that demand reliability in the most abusive and demanding environments.

Model	I.D	O.D	Length
170-TSH-N-3100	1/4"	1/2"	100'
170-SH-N-3125	3/8"	5/8"	125'
170-SH-N-350	3/8"	5/8"	50'
170-TSH-N-450	1/2"	3/4"	50'



COXREELS® SD Series "Static Discharge" cable reels are built heavy duty and designed for long lasting performance. They are specifically design to be used in combustible environments where the static buildup could ignite a spark and subsequent explosion.

Model	Hose	Length
170-SD-35	Yes	35'
170-SD-50	Yes	50'
170-SD-75	Yes	75'
170-SD-100	Yes	100'



170-112-3-150
Hand Crank Hose Reel: 3/8" I.D., 150' hose capacity, 4000 PSI, less hose



170-112Y-4
112Y Series Challenger Storage Reel: 8 GA./40', 10 GA.-75', 12 GA./150', 16 GA./300', less cord



125-72018
Lectra Clean® Heavy Duty Electrical Parts Degreaser, 539 G. This chlorinated based material quickly removes grease, oil & dirt from motor parts and other such equipment



125-72130
QD™ Contact Cleaner, 312 Grams Suitable for cleaning sensitive electronics and electrical equipment



125-73005
3-36® Multi-Purpose Precision Lubricant, 325G. A plastic safe lubricant, penetrant and corrosion inhibitor that helps prevent electrical malfunctions caused by water penetration, humidity, condensation or corrosion



125-73020
Knock'er Loose™ Penetrating Solvent, 369 G. An industrial strength, low viscosity super penetrant designed to quickly loosen and free seized, bound or frozen fasteners



125-73050
Chain and Wire Rope Lube, 284 Grams. Blend of synthetic lubricants that penetrate deep to lubricate and protect. Extends the working life of chains and wire rope and reduces wear caused by friction and corrosion



125-73500
Cutting Oil Thread Cutting Lubricant, 340 Grams. Cutting Oil is a superior thread cutting lubricant for use on all types of metals, including brass, copper and aluminum



125-75088
Brakleen® Brake Parts Cleaner - Non-Chlorinated, 396 Grams. The Brake Cleaner to use where compliance calls for a chlorine-free product. Formulated to quickly remove brake fluid, grease, oil, and other contaminants from brake linings & pads



125-75089
Brakleen® Brake Parts Cleaner, 539G Formulated to quickly & effectively remove grease, brake dust, brake fluids, oils, & other contaminants from brake parts, lining, pads



125-75097
Battery Cleaner with Acid Indicator, 312G. Instantly detects leaks and neutralizes acid. Removes corrosion by-products



Part	Description	Part	Description
192-CCW4	7/16" Combination Wrench	192-CCW10	13/16" Combination Wrench
192-CCW5	1/2" Combination Wrench	192-CCW11	7/8" Combination Wrench
192-CCW6	9/16" Combination Wrench	192-CCW12	15/16" Combination Wrench
192-CCW7	5/8" Combination Wrench	192-CCW13	1" Combination Wrench
192-CCW8	11/16" Combination Wrench	192-CCW14	1-1/16" Combination Wrench
192-CCW9	3/4" Combination Wrench	192-CCW15	1-1/8" Combination Wrench



CRESCENT
BRAND



192-CCWS4
14 Piece SAE Combination Wrench Set



192-CCWS5
15 Piece Metric Combination Wrench Set

SOCKET WRENCH SETS

Part	Description
192-CRWF0	1/4" Drive, Quick Release Ratchet
192-CRWF6	3/8" Drive, Quick Release Ratchet
192-CRWF12	1/2" Drive, Quick Release Ratchet

Part	Description
192-CSWS0	1/4" Dr., 12 Pc. Socket Wrench Set, SAE
192-CSWS2	1/4" Dr., 21 Pc. Socket Wrench Set, STD/Deep, SAE
192-CSWS3	1/4" Dr., 22Pc. Socket Wrench Set, STD/Deep, MM
192-CSWS5	1/4" Dr., 43 Pc. Socket Wrench Set, STD/Deep, SAE,MM
192-CSWS6	3/8" Dr., 11 Pc. Socket Wrench Set, SAE
192-CSWS8	3/8" Dr., 25 Pc. Socket Wrench Set, STD/Deep, SAE
192-CSWS9	3/8" Dr., 25 Pc. Socket Wrench Set, STD/Deep, MM
192-CSWS10	3/8" Dr., 52 Pc. Socket Set, SAE/MM, Deep
192-CSWS11	1/2" Dr., 12 Pc. Socket Wrench Set, SAE
192-CSWS12	1/4" & 3/8" Dr., 45 Pc. Socket Set



192-CTK84CMP
84 Piece, 1/4" and 3/8" Drive 6 and 12 point SAE/Metric Mechanic's Tool Set



181-CTK148MP
148-Piece Professional Tool Set includes 1/4", 3/8", and 1/2" quick-release ratcheting drives, with a wide selection of standard and deep sockets in the most common SAE and metric sizes



Devcon® Plastic Steel® Putty. The original metal-filled epoxy putty, it is ideal for repairing areas where welding or brazing would be impractical. Can be drilled, tapped and machined. Conforms to the requirements of MIL-PRF-24176C, Type I.



230-10110
Devcon® Plastic Steel® Putty (A)
- 1 lbs



230-10240
Devcon® Plastic Steel® 5
Minute® Putty (SF) - 1 lbs



230-10270
Devcon® Stainless Steel
Putty (ST) - 1 lbs



230-10610
Devcon® Aluminum Putty (F) -
1 lbs



230-11320
Devcon Dfense Blok Quickpatch 1
Lb. Ceramic bead-filled epoxy for
emergency repair. Exceptionally
fast curing eliminates downtime



230-11500
Zip Patch™ - 4"x9" patch.
High-technology, adhesive-
impregnated patching
system that cures at room
temperature and makes
permanent, waterproof field
repairs to pipes, tanks, and
containers.



230-11760
Devcon® Brushable Ceramic
Red provides a smooth
protective barrier against
wear, abrasion, corrosion,
erosion, and chemical attack.



230-13120
Devcon® 40Lb Epoxy
Floor Patch 45-minute
working time.
Acceptable for use in
meat and poultry plants.



230-14240
Devcon® 5 Minute®
Epoxy Gel opaque
[1-1] - 25ml Dev-
Tube™



230-14250
Devcon® 5 Minute® Epoxy
clear [1-1] - 25ml Dev-Tube™



230-14280
Devcon® Mark V Gun (1-1
And 10-1 Ratio) - Use With
50 MI Cartridge - Applicator
Gun Min 1



230-14300
Plastic Welder, 25 mL, Dual
Syringe Tube Toughened
adhesive for high strength
load-bearing bonds.



230-14310
2 Ton Clear Epoxy, 25 mL, Extremely
strong, water-resistant epoxy adhesive
that forms a powerful bond with ferrous
and non-ferrous metals, ceramics,
wood, concrete, or glass in any
combination.



230-14270
5 Minute® Epoxy
Rapid-curing, general-purpose
adhesive/encapsulant which
easily dispenses and mixes in
seconds, dries in 15 minutes
and reaches functional strength
in 1 hour



230-14277
1 Minute® Epoxy
Ultra-fast-curing adhesive gel
adhesive for filling gaps,
cracks, and holes in all
substrates



230-15565
RFlex Belt Repair Kit 1.5Lb
Coats hinged or solid plate
fastener systems to protect
them from damage



230-19510
1PT. Cleaner Blend
300 Safe, multi-purpose
degreaser for use on
heavy grease and oil
deposits on metal.
Needs no rinsing;
leaves no residue



230-15250
Devcon® Flexane® 94 Liquid, 1 lb,
Black For applications requiring a
shorter demolding time (5 hours)
Harder material than Flexane™@ 80
Liquid. Low-viscosity urethane cures
to rigid rubber



230-15800
Devcon® Flexane® 80 Liquid, 1 lb, Black
Faithfully reproduces mold detail, and cures
to semi-rigid rubber. Medium-viscosity
urethane fills voids completely. Mixes and
pours easily. Ten-hour demolding time



115-D28710
DEWALT® 14" Chop Saw
15 Amp motor for high performance without overheating



115-DWE305
DEWALT® Reciprocating Saw 12.0A, 0-2,900 SPM, with 4 Directional Keyless Blade Clamp



115-DWE43144N
DEWALT® 6" (150mm) High Performance Paddle Switch Grinder with No Lock-On



115-DWE402
DEWALT® Grinder 4-1/2" 11,000rpm 11Amp



115-DW088K
DEWALT® Cross Line Laser maintains full brightness for visibility and extends range that projects bright crossing horizontal and vertical lines for various leveling and layout applications.



115-DW292
DEWALT® 1/2" Impact Detent Pin 7.5 Amp



115-DCD785C2
DEWALT® 20V MAX* Lithium Ion Compact Hammerdrill Kit (1.5 Ah)



115-DWE7480
DEWALT® 10" Job Site Table Saw (24-1/2" Rip Capacity)



115-DCS380B
DEWALT® 20V MAX Reciprocating Saw
TOOL ONLY



115-DCS391B
DEWALT® 20V MAX 6-1/2" Circular Saw - Tool Only



115-DCG412B
DEWALT® 20V MAX Cut-Off Tool - TOOL ONLY



Part #	Description
115-DW8062	DEWALT 4-1/2" x .045" x 7/8" A60T Metal Thin Cut-off Wheel -Type 1
115-DW8063	DEWALT 5" x .045" x 7/8" A60T Metal Thin Cut-off Wheel -Type 1
115-DW8808	DEWALT 4-1/2" x 1/4" x 7/8" Premium Metal Wheel (Zirconia)
115-DW8814	DEWALT 5" x 1/4" x 7/8" Premium Metal Wheel (Zirconia)
115-DWA4166	DEWALT 6 IN 6TPI 2X Reciprocating Saw 5 Pack
115-DWA4169	DEWALT 9 IN 6TPI 2X Reciprocating Saw 5 Pack
115-DWA4186	DEWALT 6IN 14/18TPI Max Metal Reciprocating Saw Blade 5 Pack
115-DWA4188	DEWALT 8IN 14/18TPI Max Metal Reciprocating Saw Blade 5 Pack
115-DWA4176	DEWALT 6 IN 10TPI 2X Reciprocating Saw Blade 5 Pack
115-DWA4179	DEWALT 9 IN 10TPI 2X Reciprocating Saw Blade 5 Pack



115-DCB203-2
DEWALT® 20V MAX Li-Ion Compact Battery 2-Pack (2.0 Ah)

115-DCB204-2
DEWALT® 20V MAX Li-Ion Battery 2-Pack (4.0 Ah)

DURACELL®



Alkaline Batteries. Economically packaged for professional applications. Engineered for intermittent use. Lasts up to 10 times longer than super heavy duty and carbon zinc batteries in power demanding applications

Part #	Description
243-PC1300	Duracell Procell D Cell
243-PC1400	Duracell Procell C Cell
243-PC1500BKD	Duracell Procell AA Cell
243-PC1604BKD	Duracell Procell 9 Volt
243-PC2400BKD	Duracell Procell AAA Cell



243-DL123ABPK
3.0 Volt Lithium
Photo Battery
(DL123ABU)



Part #	Description
243-QU1300BKD	Quantum "D" cell
243-QU1400BKD	Quantum "C" cell
243-QU1604BKD	Quantum "9V" cell
243-QU1500BKD	Quantum "AA" cell
243-QU2400BKD	Quantum "AAA" cell

DYKEM®

DYKEM® BRITE-MARK® is a general purpose permanent marker ideal for making clear, bold markings on almost any surface. Its quick drying, oil-based paint withstands indoor and outdoor conditions without fading, chipping or losing its opacity

The DYKEM® TUFF GUY™ is a heavy-duty, truly permanent ink marker which features a non-xylene based formula. This valve-action marker is ideal for permanent identification of parts or accessories



Part	Description
253-84001	BRITE-MARK® 916 Blue
253-84002	BRITE-MARK® 916 Black
253-84003	BRITE-MARK® 916 White
253-84004	BRITE-MARK® 916 Yellow
253-84005	BRITE-MARK® 916 Orange
253-84006	BRITE-MARK® 916 Red



Part	Description
253-44175	Ink Markers Tuff Guy White
253-44177	Ink Markers Tuff Guy Green
253-44179	Ink Markers Tuff Guy Blue
253-44203	Ink Markers Tuff Guy Black
253-44401	Ink Markers Tuff Guy Yellow
253-44819	Ink Markers Tuff Guy Red

DYKEM® Cross Check™ Torque Seal® Tamper-Proof Indicator Paste provides a convenient visual method for identification of vibratory loosening or tampering in nuts, bolts, fasteners, and assemblies. Provides warranty protection against tampering. Marks will be easily broken if parts are tampered with or become loose. Highly visible marks.



Part	Description
253-83314	Cross Check Torque Seal, Orange, 1 oz
253-83315	Cross Check Torque Seal, Green, 1 oz
253-83316	Cross Check Torque Seal, Red, 1 oz
253-83317	Cross Check Torque Seal, Yellow, 1 oz
253-83318	Cross Check Torque Seal, Blue, 1 oz
253-83319	Cross Check Torque Seal, White, 1 oz

LIFTING MAGNETS

Ultralift LM Safe, General-Purpose Lifting

- Locking switch handle mechanism



Product No	UK Product No.	Self Weight	Dimensions						Flat Section			Round Section			
			A	B	C	D	E	F	SWL	Thickness Min	Length Max	SWL	Diameter Max	Length* Max	
	IMPERIAL	METRIC	lb	inches						lb	inches		lb	inches	
LM0275	LM0125	9.9	2.1	2.4	4.3	5.9	3.0	5.9	275	0.8	60	110	10	60	
LM0550	LM0250	18.7	3.0	2.8	6.5	8.3	3.5	7.9	550	1.0	60	220	12	60	
LM1100	LM0500	38.5	4.1	3.5	8.9	11.1	4.2	9.6	1100	1.2	80	440	16	80	
LM2200	LM1000	80.3	4.4	4.1	12.8	15.4	5.4	14.4	2200	1.8	120	880	18	120	
LM4400	LM2000	173.8	6.7	5.2	15.7	19.0	7.3	20.7	4400	2.8	120	1760	24	120	

MAGNET MATERIALS

Alnico Deep Pots

Material **Alnico 5** (magnet), **mild steel** (body), **aluminum** (spacer)
Max temperature **220°C / 428°F**



Product No.	Diameter	Height	Thread size	Weight	Max pull	Units / pack
IMPERIAL	inches			lb		
829	0.375	0.594	M3	0.01	2.2	10
830	0.500	0.625	M4	0.03	4.4	10
831NF	0.689	0.629	10 UNF	0.05	5.8	10
832NF	0.807	0.748	10 UNF	0.09	8.8	5
833NF	1.062	1.000	10 UNF	0.19	13.4	5
834NF	1.377	1.181	10 UNF	0.41	32.5	2

Alnico Power Magnets



Product No.	Length	Height	Width	Width of gap	Hole size	Weight	Max pull	Units / pack
IMPERIAL	inches					lb		
811	1.181	0.787	0.787	0.590	0.197	0.13	10	5
812	1.575	0.984	0.984	0.787	0.197	0.26	20	5
813	1.771	1.181	1.181	0.906	0.197	0.40	26	2
814	2.283	1.377	1.594	1.094	2 × 0.311	0.81	52	1
815	2.756	1.625	2.251	1.342	2 × 0.311	1.56	82	1
816	3.125	2.125	3.250	1.515	2 × 0.374	3.19	103	1
817	2.374	1.575	2.440	1.250	n/a	1.76	77	1
818	3.125	2.125	3.374	1.874	n/a	3.96	132	1

Alnico Shallow Pots

Material **Alnico 5** (magnet), **mild steel** (body)



Product No.	Diameter	Height	Hole size M3 (csn)	Screw head size	Weight	Max pull	Units / pack
IMPERIAL	inches				lb		
826	0.750	0.295	0.145-0.263	M3 Csk	0.02	6.6	10
827	1.125	0.344	0.189-0.339	M4 Csk	0.06	11.0	10
828	1.500	0.407	0.189-0.339	M4 Csk	0.16	28.6	5

Alnico Pocket Magnets

E802 **Alnico 5**,
E803 **Alnico 2**



Product No.	Length	Height	Width	Width of gap	Weight	Max Pull	Units / pack
IMPERIAL	inches				lb		
E802	0.874	1.000	0.311	0.252	0.07	5.3	10
E803	1.063	1.378	0.625	0.311	0.20	8.8	5

TOOLROOM MAGNETS

WELDING TOOLS

Magnetic Trays

Stainless steel with rubber coated ferrite (ceramic) magnet in base.
Holds ferrous objects to the tray and the tray to ferrous objects.



Product No.	Dimensions
IMPERIAL	inches
E630	14.2 x 6.3
E631	11.5 x 10.7
E632	9.5 x 5.6
E633	5.9 D
E634	4.3 D

Magnetic Variable Clamp

Maximum temperature **120°C / 248°F**

Fast accurate holding of ferrous sheets and tubes for welding and assembly work.



Product No.	Length	Height	Width	Weight	Pull
IMPERIAL	inches			lb	
E952	7.68	7.87	0.43	1.10	44

WORKSHOP TOOLS

Magnetic Sweeper

Quickly clear factory, workshop and garage floors, car parks and sports pitches of potentially dangerous and damaging metal debris.

NEW easy-clean design – quick contamination release trigger mounted on handle.

Adjustable length handle.

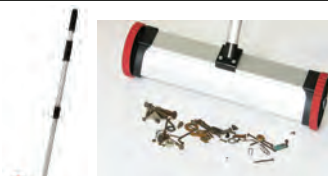

Product No.	Head Width
IMPERIAL	inches
MSW385	16

Quick Clamps

Fast and accurate holding of ferrous metals at different fixed angles.

Also suitable for retrieval applications.



Product No.	Length	Height	Width	Weight	Pull
IMPERIAL	inches			lb	
E951	3.95	2.56	0.47	0.66	22
E953	3.95	2.56	0.83	0.88	33

COMPLETE MAGNETIC BASES

Used in the measurement, inspection and positioning of workpieces with dial indicators; to measure the flatness of a workpiece after grinding or milling; for checking concentricity of a workpiece. Stands will clamp onto curved and flat surfaces.

Product No.	Product No. North America	Base Part No.	Switching type	Fitment Part No.	Fitment type	IMPERIAL Max Pull lb
E905	M19713ASS	E905WF (M15885)	Lever	RP995BL	Heavy duty	176
E906	M19712ASS	E905WF (M15885)	Lever	RP991BL	Heavy duty with fine adjustment	176



DIAL CALIPER

- Standard: DIN 862
- High-quality shockproof dial caliper
- Hardened stainless steel rack

Product No.	Range	Resolution
		inches
MW143-15I	0-6	0.001
MW143-20I	0-8	0.001
MW143-30I	0-12	0.001

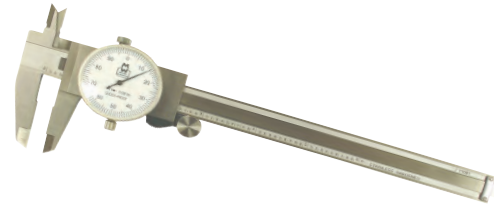

ABSOLUTE DIGITAL CALIPER

- Standard: DIN 862
- True Origin Absolute digital caliper
- Large LCD Display

Product No.	Range (mm)	Range (inch)	Resolution (mm)	Resolution (inch)	Length of Jaws
MW110-15DAS	0-150	0-6	0.01	0.005	40mm
MW110-20DAS	0-200	0-8	0.01	0.005	40mm
MW110-30DAS	0-300	0-12	0.01	0.005	40mm



- Standard: DIN 878
- With Tungsten carbide measuring tip
- Shockproof

Product No.	Range (mm)	Range (inch)	Resolution (mm)	Resolution (inch)	Bezel Diameter	Stem Diameter	Description
MW401-02	-	0-1	-	0.001	58mm	3/8" spindle dia.	Ear back
MW401-05	0-25	1	0.01	0.001	60mm	8mm spindle dia.	Ear back



TRADITIONAL ENGINEERS' LEVEL

- Main vial sensitivity of 1 minute
- Each level is fitted with a main, cross and plumb vial
- Main vial protected by rotating shroud
- Vial solution maintains colour and fluidity under all workshop conditions
- Precision ground cast base with vee groove for location on cylindrical work

Product No.	Length	Width	Height	Resolution
				inches
ELM	12	1.42	2.28	0.0035" per foot



MECHANICAL OUTSIDE MICROMETER

- Standard: DIN 863
- Hammertone finished frame with high quality insulated grip
- With tungsten carbide measuring faces and constant force ratchet

Product No.	Range	Resolution
	inches	
MW200-01I	0-1	0.0001
MW200-02I	1-2	0.0001



DIGITAL MICROMETER

- Standard: DIN 863
- Digital outside micrometer with 'easy read' large 7.5mm character height, digital display
- Tapered for easier access to difficult areas

Product No.	Range (mm)	Range (inch)	Resolution (mm)	Resolution (inch)
MW200-01DDL	0-25	0-1	0.001	0.00005
MW200-02DDL	25-50	1-2	0.001	0.00005



TELESCOPIC GAUGE SET

- For quick inside measurement and determination of inside diameters
- Spring loaded plunger that expands in the bore or groove
- Satin chromed body

Product No.	Range (inch)	Pack Quantity
MW315-01	5/16-6	6 - Pieces



PRECISION COMBINATION SET

- Fully hardened and tempered precision rules with deeply etched graduations on both sides for ease of reading and long life
- Centrally mounted protractor vial allows unrestricted viewing
- Centre head offers a fixed 90° angle, for finding the centre of round bar stock up to 120mm diameter

Product No.	Description
MWCSME12	Full set inc. 300mm/12" rule, Protractor head, Square head and Centre head



COMBINATION SET

- Square head, protractor head and centre head
- Hardened and ground slide ways
- Stainless steel rule with engraved graduations

Product No.	Range	Description
MW520-01	180°	4 items in set



*Metric and inch scale rule

QUICK RELEASE WOODWORKING VICE

Quick release trigger opens and closes the vice quickly without using the mainscrew. Fitted with an adjustable front stop- or dog- that gives an additional clamping facility when used with a bench stop, to provide a normal vice and a tail vice in one tool. To increase safety, the fused tommy bar will bend before the vice can become over-stressed.

Product No.	Jaw Width	Throat Depth (mm)	Opening (mm)	Net Weight (kg)	Qty per pallet
EWWR7-NA	7"/178mm	80	202	9.4	60
EWWR9-NA	9"/230mm	106	260	15.5	32
EWWR10-NA	10"/254mm	100	380	17.7	24



MECHANICS' VICE

The body and sliding jaw are manufactured from high quality grey cast iron, which has excellent shock absorbing qualities. The precision milled slide ensures a fast, smooth operation, while the fused tommy bar will bend before the vice can become over-stressed. Includes hardened steel replaceable jaws and fixing holes for bench mounting.

Product No.	Jaw Width	Throat Depth (mm)	Opening (mm)	Clamping Force (kN)	Net Weight (kg)	Qty per pallet
EMV-1	3"/75mm	48	82	20	4.8	144
EMV-3	4"/100mm	63	109	25	9.3	90
EMV-5	5"/125mm	73	136	30	15.8	40
EMV-6	6"/150mm	86	168	35	24.2	36
EMV-8	8"/200mm	103	208	45	38.1	24



STRAIGHT JAW LOCKING PLIER

- Wear resistant serrated and hardened jaws provide a firm grip
- Body and jaws made from high grade chrome molybdenum steel
- Guarded release trigger to protect against accidental release

Product No.	Size	Jaw Capacity
E7R	7" (175mm)	1.5/16" (34mm)
E10R	10" (250mm)	1.3/4" (45mm)



CURVED JAW LOCKING PLIER

- Wear resistant serrated and hardened jaws provide a firm grip
- Body and jaws made from high grade chrome molybdenum steel
- Guarded release trigger to protect against accidental release

Product No.	Size	Jaw Capacity
E10CR	10" (250mm)	1.7/8" (48mm)



CURVED JAW LOCKING PLIER WITH WIRE TRIMMER

- Wear resistant serrated and hardened jaws provide a firm grip
- Body and jaws made from high grade chrome molybdenum steel
- Guarded release trigger to protect against accidental release

Product No.	Size	Jaw Capacity
E5WR	5" (125mm)	1.1/4" (32mm)
E7WR	7" (175mm)	1.1/2" (39mm)
E10WR	10" (250mm)	1.7/8" (48mm)



LONG NOSE LOCKING PLIER WITH WIRE CUTTER

- Wear resistant serrated and hardened jaws provide a firm grip
- Body and jaws made from high grade chrome molybdenum steel
- Guarded release trigger to protect against accidental release

Product No.	Size	Jaw Capacity
E6LN	6" (150mm)	2" (51mm)



LOCKING C-CLAMPS WITH SWIVEL PADS

- Wear resistant serrated and hardened jaws provide a firm grip
- Guarded release trigger to protect against accidental release

Product No.	Size	Jaw Capacity
E6SP	6" (150mm)	1.3/4" (45mm)
E11SP	11" (275mm)	3.1/8" (80mm)



LOCKING C-CLAMPS WITH REGULAR PADS

- Wear resistant serrated and hardened jaws provide a firm grip
- Guarded release trigger to protect against accidental release

Product No.	Size	Jaw Capacity
E6R	6" (150mm)	1.3/4" (45mm)
E11R	11" (275mm)	3.1/8" (80mm)



BOLT CUTTERS - HIGH TENSILE - TUBULAR HANDLES

- Centre cut, strap adjusted bolt cutters with lightweight tubular handles that do not compromise strength

Product No.	Size	Cutting Capacity
ETBC14	14" (355mm)	3/16" (5.0mm) max
ETBC18	18" (460mm)	1/4" (6.4mm) max
ETBC24	24" (610mm)	5/16" (7.9mm) max
ETBC30	30" (762mm)	3/8" (9.5mm) max
ETBC36	36" (915mm)	7/16" (11.1mm) max



BOLT CUTTERS - HIGH TENSILE - FORGED HANDLES

- Centre cut, arm adjusted bolt cutters with solid forged handles for maximum strength

Product No.	Size	Cutting Capacity
EFBC14	14" (355mm)	3/16" (5.0mm) max
EFBC18	18" (460mm)	1/4" (6.4mm) max
EFBC24	24" (610mm)	5/16" (7.9mm) max
EFBC30	30" (762mm)	3/8" (9.5mm) max
EFBC36	36" (915mm)	7/16" (11.1mm) max
EFBC42	42" (1070mm)	1/2" (13.0mm) max

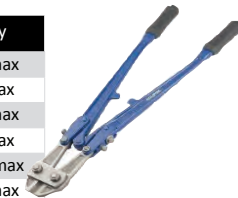

ONE HANDED BAR CLAMPS

- Ideal for a wide range of clamping and spreading tasks when gluing, sawing, drilling etc.

Product No.	Clamping Capacity	Spreading Capacity (min)	Spreading Capacity (max)	Jaw Depth	Type
EOHBC6	6" (150mm)	6.5/8" (168mm)	13.3/8" (340mm)	3.3/8"	Single
EOHBC6X2	6" (150mm)	6.5/8" (168mm)	13.3/8" (340mm)	3.3/8"	Pair
EOHBC12	12" (300mm)	6.5/8" (168mm)	19.1/2" (495mm)	3.3/8"	Single
EOHBC18	18" (450mm)	6.5/8" (168mm)	25.3/8" (645mm)	3.3/8"	Single
EOHBC24	24" (600mm)	6.5/8" (168mm)	31.1/2" (800mm)	3.3/8"	Single
EOHBC36	36" (910mm)	6.5/8" (168mm)	43.1/2" (1105mm)	3.3/8"	Single





EM100

8"X12" Carpenters Framing Square Steel Easy-to-read numbers. High-quality, standard blade-and-tongue design. Strong, epoxy-finished steel

EM230

Combo Square 12 Tradesman. Professional Square E-Z slide pad lining for smooth blade sliding action. Metal square head. Self-aligning drawbolt

EM1110

16"X24" Steel Tradesman Square Easy-to-read numbers. High-quality, standard blade-and-tongue design. Punched hang hole. Stamped graduations strong, epoxy-finished steel



EM36

Magnetic Polycast™® Protractor Durable Polycast™® construction. Magnetic base and edge

EM581-48 48" Magnetic Unitek Level Beveled end plates protect from shock. Solid I-beam frame with magnetic edge. Top read window

EM581-24 24" Magnetic Unitek Level Beveled end plates protect from shock. Solid I-beam frame with magnetic edge. Top read window

EM2990

Heavy Duty Rafter Square 1-piece aluminum extrusion outperforms brittle die casts. Stamped conversion tables. Thick edge makes for a safer saw guide.

EM3990 12 inch heavy duty magnum rafter square



EM81-9

9 inch Heavy Duty Magnetic Torpedo Level



510-EVOSAW185
7-1/4 inch. Steel Cutting Circular Saw with 185 blade St Cuts mild steel without excessive heat, burrs or the necessity of coolants



510-EVOSAW380
14 inch Steel Cutting Chop Saw W/14bladest



510-EVOMAG42
1-1/8 in. DIA. X 2 in. Depth Magnetic Drilling System



510-STEELSAW5
9 inch Steel Cutting Circular Saw W/230bladest



GARCHR2FL
Cougar Round point shovel, equipped with a tempered steel blade, forward turned steps for maximum power, hardwood handle



GARCHR2FD
Round point shovel, wood handle, D-grip, tempered steel blade, forward turned footsteps for maximum power



GARCHS2L
Square point shovel, hollow back tempered steel blade, forward turned steps, hardwood handle, lh



GARCHS2D
Square point shovel, hollow back tempered steel blade, forward turned steps, hardwood handle, dh



GARGIPP21KD
Pro Series All-purpose Snow pusher, 21 in. polypropylene blade. Premium stained ash handle with a poly D-grip. kd Perfect for intensive uses



GARYPP24SAKD YUKON ERGO
Snow pusher, 24 in. blue polyblade. Its light and robust aluminum handle is designed to offer you maximum comfort



GARNPP26KD
Snow Pusher 26" polyblade to push light snow away from large areas



GARNP139KD
Nordic Snow shovel, 13.9 in. poly blade, stained ash handle



GARYFSW4 YUKON Ice scraper, industrial grade 3.75", forged and tempered steel blade, profiled premium ash handle, lh



GARBP8
Wheelbarrow poly tray, 8 cu ft with a maximum capacity of 360lb (163.3kg) is made of a single piece of corrosion proof poly and has steel front tray braces, stabilizing bars and legs. The dual wheels allows moving heavy loads easily. It has 60 inch (152.4cm) square hardwood handles and 2 15 inch (38.1cm) tires with pneumatic 2 ply



Part	Description
GEN04010012	The Pumper Marker White 12/Pack
GEN04010013	The Pumper Marker Yellow 12/Pack
GEN04010014	The Pumper Marker Black 12/Pack
GEN04010015	The Pumper Marker Red 12/Pack
GEN04010016	The Pumper Marker Blue 12/Pack
GEN04010017	The Pumper Marker Green 12/Pack





Convenient carrying handle. Raised flow-through base dissipates heat. Rugged, lead-free galvanized steel body with durable powder coat paint finish. Self-closing cover isolates contents from fire sources



Part	Description
400-09100	Oily Waste Can, 6 gallon, foot-operated self-closing cover, red
400-09300	Oily Waste Can, 10 gallon, foot-operated self-closing cover, red
400-09500	Oily Waste Can, 14 gallon, foot-operated self-closing cover, red
400-09700	Oily Waste Can, 21 gallon, foot-operated self-closing cover, red

400-26750
55 Gallon Safety Drum Cover. Self-closing Drum Cover turns a drum into a fire-safe receptacle for combustible waste. Simply use a screwdriver and wrench to attach the cover to a drum



400-26800
Smoker Ceasefire Assembly Pewter Gray. Innovative self-extinguishing design safely collects unsightly cigarette butts and reduces the risk of fire. Made of flame-retardant, sturdy polyethylene. Won't rust, dent, or crack



400-26800B
Original Smoker's Cease-Fire® Cigarette Butt Receptacle, Cap. 4 gal, bucket included, poly beige



Part	Description
400-28715	EcoPolyBlend™ Spill Tray, 46"x 16" x 5-1/2", rigid poly, Black
400-28716	EcoPolyBlend™ Spill Tray, 38"x 26" x 5-1/2", rigid poly, Black
400-28717	EcoPolyBlend™ Spill Tray, 48"x 23" x 5-1/2", rigid poly, Black
400-28718	EcoPolyBlend™ Spill Tray, 38"x 34" x 5-1/2", rigid poly, Black
400-28719	EcoPolyBlend™ Spill Tray, 47"x 33" x 5-1/2", rigid poly, Black



400-7150100
Type I Steel Safety Can For Flammables, 5 Gallon (19L), S/S Flame Arrester, Self-Close Lid, Red



400-7250120
Type II AccuFlow™ Steel Safety Can for flammables, 5 Gallon, S/S flame arrester, 5/8" metal hose, Red



400-7250130
Type II AccuFlow™ Steel Safety Can for flammables, 5 Gallon, S/S flame arrester, 1" metal hose, Red



400-7150200
Type I Steel Safety Can For Flammables, 5 Gallon (19L), S/S Flame Arrester, Self-Close Lid, Yellow



400-7250220
Type II AccuFlow™ Steel Safety Can for flammables, 5 Gallon, S/S flame arrester, 5/8" metal hose, Yellow



400-7250230
Type II AccuFlow™ Steel Safety Can for flammables, 5 Gallon, S/S flame arrester, 1" metal hose, Yellow



400-893020
Justrite 30 Gallon Cabinet Self Closing Yellow Flammable Safe Sure-Grip® EX door, self close, 1 adjustable shelf Capacity: 30 Gallon, 114 liters Dimensions: 43" W x 44" H x 18" D



400-894500
Sure-Grip® EX Flammable Safety Cabinet, Cap. 45 Gallon, 2 shelves, 2 manual-close doors



400-896200
Justrite Sure-Grip EX (1) Vertical 55 Gallon Drum Storage Cabinet with 2 Manual Doors Yellow Use these vertical drum safety cabinets to safely store 30- to 55-Gallon (110- to 200-L) drums

KENNEDY®



444-305XB
5 Drawer Maintenance Chest
Brown Wrinkle Steel Ball Bearing Slides
39 3/8 x 18x 16 1/2



444-310XB
10 Drawer Tool Roller
Cabinet Brown Wrinkle Steel
Ball Bearing Slides
39 3/8 x 18x 35



444-360B
10 Drawer Mechanic's Chest
Brown Wrinkle
26 1/8 x 12x 18 7/8



444-K20B
20" Professional Tool Box



444-K24B
24" Professional Tool Box



444-266R
6-drawer Mechanic's Chest with
friction Slides Red
26 1/8 x 12x 14 3/4



409-D2000-7CST
Ironworker's Pliers Heavy Duty
Cutting Twists and cuts soft
annealed rebar tie wire. Cuts
ACSR, screws, nails and most
hardened wire. Spring-loaded
action for self-opening



409-D201-7CST
9" Ironworker's Work Pliers
Twists and cuts soft annealed
rebar tie wire. Hook bend handle
Spring-loaded action for self-opening
Induction hardened cutting knives
for long life. Hot-riveted joint
ensures smooth action and
handle wobble.



409-D213-9ST
9" High-Leverage
Ironworker's Work Pliers.
Twists and cuts soft
annealed rebar tie wire
High-leverage design



409-D248-9ST
9" High-Leverage Diagonal-
Cutting Pliers - Ironworker's.
The 13° degree angled head
makes it easier to work in
confined spaces while the
hooked handle improves the
grip and reduces slippage



409-1656-30H
Chicago Grip with Latch 0.53
Capacity Grips have a round,
smooth inside jaw contour making it
perfect for work with stranded
copper cables. These smooth jaws
grip with maximum contact and are
less likely to cause cable
deformation



409-27400
Tie-Wire Reel. Save
time and keep your tie
wire organized. This
reel is made of
lightweight aluminum
and can be used either
left- or right-handed



409-44004
Lightweight Lockback Knife
2-1/2" Blade is AUS8 stainless
hardened to 58-59 Rc. Premium
quality blade offers superior edge
holding. Impact-resistant nylon
resin handle with rubber insert.
Reversible thumb stud provides
easy one-handed opening



409-5278N-26D
Full Floating Body Belt 42" to 50".
Latigo-leather belt pad is laced and
stitched with two pocket tabs.
Rolled-edge leather belt cushion for
comfort when leaning back. 5" (127
mm) overall width. Padded for
maximum comfort and body fit.

PIPE WRENCHES AND WATER PUMP PLIERS



KNIPEX Alligator® Water Pump Pliers

pliers black atramentized, head polished, handles with non-slip plastic coating, self-locking on pipes and nuts: no slipping on the work piece and low hand force required



KNIPEX Cobra® – the Hightech Water Pump Pliers. No more time-consuming presetting of the required opening size. Just position the upper jaw to the workpiece, push button and move close the lower jaw, ingeniously simple



Part	Description
414-8801180SBA	7.25" ALLIGATOR® Plier
414-8801250SBA	10" ALLIGATOR® Pliers
414-8801300SBA	12" ALLIGATOR® Pliers
414-8808250SBA	10 ALLIGATOR® Pliers-1,000V Insulated

Part	Description
414-8701125SBA	5 " COBRA® Plier
414-8701180SBA	7.25 " COBRA® Pliers
414-8701250SBA	10 " COBRA® Pliers
414-8701200SBA	12" COBRA® Pliers
414-8701400SBA	16 " COBRA® Pliers
414-8701560	22" COBRA® Pliers



414-1240200

Self-Adjusting Insulation Strippers for single, multiple and fine stranded conductors with plastic or rubber insulation



414-169501SB

ErgoStrip® Universal Dismantling Tool. For the fast and precise dismantling and stripping of all common round and damp-proof installation cables



414-1640150

Dismantling Tool For dismantling round cables exceeding 25.0 mm dia. Removes all kinds of insulation layers



442-1174633

Non-Flammable Electrical Contact Cleaner 12 oz. Non-Flammable



442-1324007

Fixmaster Fast Cur Poxy Pak Epoxy (C 1 Fl. oz. Syringe



442-1329467

Threadlocker 243 Primerless Oil Tolerant/Medium Strength A general purpose, medium strength threadlocker with improved oil tolerance for fasteners between 1/4" and 3/4" diameters 50 mL Bottle.



442-1329837

243 Primerless, Oil Tolerant, Removable, Medium Strength Blue Threadlocker 10 ml



442-1330583

Threadlocker 263 High Strength/Rapid Cure 10 ml Bottle



442-1330585

Loctite 263 Primerless, Red Threadlocker 50 ml Bottle



442-2087069

Loctite® 567 is an off-white, low strength, thixotropic methacrylate thread sealant. it cures in the absence of air and by contact with metals when confined within threads up to M80/r3" 250mL



442-37087

Loctite® QuickStix™ 248™ Blue Threadlocker Medium Strength 19g Stick



442-1616692

Loctite SF7900 Ceramic Shield For Welding is a ceramic dry film protective coating for MIG/MAG welding processes 9.5 oz. Aerosol



442-18396
SF 770™ Primer
Adhesion Promoter for
Loctite instant adhesives
on hard-to-bond plastics
and elastomers
1.75 Fl. oz. Glass Bottle



442-18398
PRISM® 426 Black
Toughened Gel
20g Tube



442-20166
5900 Heavy Body RTV
Silicone Flange Sealant
300 mL Cartridge. Non-
corrosive, low odor, and
low volatility. Provides
instant seal. Superior
flexibility and adhesion



442-21348
SF 7649™ MIL-SPEC Primer
decreases the set-up time of
Loctite brand threadlockers and
increases breakaway torque on
most fastener surfaces.
4.5 oz. aerosol can



442-24221
Threadlocker 242 Medium
Strength. A general
purpose, removable
threadlocker for fasteners
between 1/4" and 3/4"
diameters. Controlled
lubricity for accurate
clamp loads. Parts can be
separated using hand
tools 10 mL Bottle



442-24231
242 Mil Spec Medium
Strength Blue
Threadlocker
50 ml bottle



442-24241
Threadlocker 242 Medium
Strength. A general purpose,
removable threadlocker for
fasteners between 1/4" and 3/4"
diameters. Controlled lubricity
for accurate clamp loads. Parts
can be separated using hand
tools 250 mL Bottle



442-26221
Threadlocker 262 High Strength.
A permanent threadlocker for
fasteners up to 3/4" in diameter.
Excellent for preventing rust and
corrosion in extreme chemical/
environmental conditions. High
lubrication for easy assembly
10 mL Bottle



442-26231
Threadlocker 262 High
Strength. A permanent
threadlocker for fasteners up
to 3/4" in diameter. Excellent
for preventing rust and
corrosion in extreme
chemical/environmental
conditions. High lubrication
for easy assembly
50 mL Bottle



442-26241
Loctite® 262 is a red,
general purpose, medium to
high strength, thixotropic
methacrylate-based
adhesive. Steel fixture time
is 15 min, brass 8 min and
stainless steel 180 min. It
fluoresces under UV light to
allow monitoring
250mL Bottle



442-27131
Threadlocker 271 High
Strength. Easy to apply and
use. Low viscosity
threadlocker for fasteners up
to 1 in diameter. Permanently
seals threaded fasteners
50 mL Bottle



442-27731
277 Large Bolt High
Strength Red
Threadlocker. Protects
threads from rust and
corrosion. Removable
with heat and hard tools
50mL Bottle



442-29348
LOCTITE® UK U-05FL
Urethane Structural
Adhesive is a high
Strength, fast setting,
highly flexible adhesive
for metal bonding. 5
minute working life
50mL



442-30540
Black Contact Adhesive
Loctite® Black Contact Adhesive is
a professional, solvent-based
adhesive with neoprene that blends
in with black-colored fabrics,
rubbers, weather stripping, and
other porous materials. Fast drying
and waterproof. Allows repositioning
of the parts after initial contact
5 Fluid oz. Tube



442-41450
414 Super Bonder Instant
Adhesive. is a colorless to
straw-colored, transparent,
general purpose ethyl-based
cyanoacrylate liquid instant
adhesive. It is suitable for
plastics, rubbers and metals.
It has a fixture time of
2 -10 secs 1 oz

LOCTITE®



442-45440
454 Prism Instant Adhesive Gel Clear Bonds dissimilar parts. Can be applied to vertical surfaces. Excellent for almost all surfaces. Ideal for porous substrates and rough and acidic surfaces
20g Tube



442-46551
404 Quick Set Instant Adhesive. General Purpose is designed for general maintenance and repair, one part, room temperature cure, instant adhesive 0.333 oz, Bottle



442-49550
Loctite® 495™ Super Bonder® Instant Adhesive. Cyanoacrylate Adhesives Designed to bond rubber, metal, and plastic parts with gaps to .004" 1.0 oz. Bottle



442-51531
515 Gasket Eliminator Flange Sealant. Flexes with flanges that move in service. Makes flexible gaskets for rigid machined flanges with less than 0.015" gap
50mL Tube



442-59630
Superflex Red High Temp RTV Silicone Adhesive Sealant makes gaskets that resist temperatures to 600°F (315°C) intermittent. Resists aging, weather and thermal cycling without shrinking, cracking or hardening. Fills gaps to 0.25 " 80mL Tube



442-59875
598 Black High Performance RTV Silicone Gasket Maker is designed for dealership warranty requirements, ensures extended drivetrain warranty compliance. Fast-curing formula. Sensor-safe, low odor, non-corrosive 300mL Cartridge.



442-76732
Silver Grade Anti-Seize 8 oz brush top. Heavy duty, temperature resistant, petroleum-based lubricant compound fortified with graphite and metallic flake. Inert, will not evaporate or harden in extreme cold or heat 8 oz.



442-98853
LOCTITE® Fixmaster® Metal Magic Steel™ is a versatile, single component, easy to use, steel filled epoxy repair putty. It is applied like a putty and when cured it has a high compressive strength and good adhesion to most surfaces 4 oz.



442-95555
Loctite® Fixmaster Magna-Crete is a two-component, rapid setting concrete repair and grouting system. Chemically resistant to most common liquids and chemicals. Bonds to concrete, wood, glass, steel, and construction materials 5 gal.



428-C00516
Cold Galvanize Corrosion Inhibitor, 95% zinc-rich galvanized coating. Dries in 3 - 5 minutes Electrochemically protects bare metal
14 oz. Aerosol Can



428-C01020
HDX Cleaner/Degreaser Heavy-duty action removes oil, grease, wax, dirt, moisture, tar, brake fluid and other contaminants. Low odour. No residue. No rinsing. Nonconductive. Nonflammable. Quick penetration 19 oz.



428-C01216
Dual Action Aquacut Cutting Fluid Corrosion inhibitors prevent flash rusting. Does not contain sulfur, chlorine, or oils. Excellent in applications where cooling of the tool is desired. Nonflammable. Nonhazardous. Provides fine finishes. Safe on all metals, except magnesium. Water-based formula 16 oz.



428-C01420
Presolve® Orange Degreaser High performance industrial cleaner which cleans on contact Ideal for removing grease, tars, and oils. Fast acting, deep penetration. Low residue 15 oz.



428-C01716
Food Grade Silicone Lubricant 10 oz. •Metal detectable plastic components-DETEX®. Dry film will not attract dust or dirt. Fast evaporating. Ideal for releasing molded parts 454 mL



428-C01916
LST Penetrant Specially formulated with low surface tension for fast penetrating action. Loosens rust and corrosion to free frozen parts Powerful foaming action provides complete surface coverage 312g



428-C02016
TKX All-Purpose Lubricant Excellent all purpose lubricant. Loosens rusted or frozen parts Protects against corrosion. High flash point of 175°F (79°C)



428-C02316
KB-88 The Ultimate penetrant Formulated to attack and quickly release rusted and corroded nuts, bolts, hinges, and other frozen components



428-C02416
Chain Mate Chain & Wire Rope Lubricant. Fortified with molybdenum disulfide. Increases the life of chains and wire ropes. Effective under extreme temperature and pressure ranges. Deep penetration to the core of wire ropes. Reduces wear caused by friction and corrosion Lubricant and corrosion protectant



428-C02705
Precision Clean Multi-Purpose Cleaner Degreaser A multi-purpose concentrated cleaner/degreaser precisely formulated for industry; removes stubborn soils, greases, oils, sludge, and soot



428-C02820
EM-CitroEmulsion Degreaser. Low foaming viscous liquid enhances contact time by clinging to the soil and surface, safe on most surfaces. Neutral pH with no caustics, acids, chlorinated solvents, alcohols, or ozone depleting solvents



428-C03116
CFC FREE - Electro Contact Cleaner. Ideal for electronic and fine parts. Cleans and degreases delicate precision mechanisms. Penetrating action removes oil, grease, dirt, flux, and other contaminants



428-C03520
ZeroTri 12 Aerosol Can 15 oz. Does not contain chlorinated solvents. Fast evaporating. Heavy-duty solvent. Ideal for cleaning metals. Instant degreasing action. Instant penetrating action. Inverted spray valve. No rinsing and no residue. Safe to use on most surfaces



428-C03620
TriFree Brake Cleaner Heavy-duty performance Instant degreasing action Improves brake performance. Helps stop disc brake squeal. Powerful jet spray



428-C03816
White Lithium Grease With PTFE Rapidly forms into a pure white grease that will not melt or wash away. Provides maximum lubrication Rust and oxidation inhibitors protect metal. Pure white color allows easy visual inspection. Heat and water resistant. Acceptable for use in Canadian Food Processing Establishments



428-C04015
NoFlash® NUPrecision Contact Cleaner. An aggressive non-flammable solvent blend for the removal of dirt, moisture, dust, flux and oxides from the internal components of electronic or precision equipment



428-C05710
QB Duster Precision Duster Quick blast precision duster removes contaminants, dirt, dust, and other soils. Excellent for use on electronics and delicate mechanisms. Non-flammable, odorless, and leaves no residue. Moisture free



428-C09200
Workplace Hand Cleaner Towels 6 Buckets 72 wipes/pail. Deep cleaning, non-scratching abrasives quickly remove embedded grime. Disposable. Fast acting. Leaves hands clean, conditioned and softened. Pre-moistened



428-C30116
LPS 1® Greaseless Lubricant. Provides a dry, thin, lubricating film. Resists oil, dust, and dirt build-up. Fast acting penetration Loosens rusted or frozen parts



428-C30216
LPS 2® Heavy-duty Lubricant Strong, multi-purpose lubricant, and penetrant with added corrosion protection Provides a non-drying, light, oily film for use on indoor/outdoor equipment. Reduces wear caused by friction and corrosion Loosens rusted or frozen parts



428-C30316
LPS 3® Premier Rust Inhibitor. Protects for up to 2 years indoors. Prevents rust and corrosion. Provides non-sling lubrication Self-healing, soft, waxy film Safe to use on most surfaces



293-L0034-035
White Motor Assembly Grease: A multi-purpose, white. A smooth light-bodied grease that contains a zinc-oxide anti-wear additive made especially for motor assembly and engine rebuilding 35 lb Pail



293-L0034-063C
Spray Lube "A" - White Lithium Grease: A multi-purpose, white lithium-based lubricant of medium density. Sprays like a fluid, congeals to a grease 12 Cans/Case



293-L0034-094CASE
White Motor Assembly Grease. A smooth light-bodied grease that contains a zinc-oxide anti-wear additive made especially for motor assembly and engine rebuilding 36 – 10 oz. Tubes/Case



293-L0067-001CASE
Multi Purpose Lithium-Based Grease High film strength, exceptional resistance to water, steam and other adverse conditions. 24/14 oz. Cans/Case



293-L0067-035
Multi-purpose Lithium-Based Greases. Traditionally popular general purpose greases. Available in 4 N.L.G.I. Densities for a wide range of applications. 35 lb Pail



293-L0067-092
Multi-purpose Lithium-Based Greases. Traditionally popular general purpose greases. Available in 4 N.L.G.I. Densities for a wide range of applications. 10 oz. tube 36 Tubes/Case



293-L0072-098
Multi-Purpose Lithium Grease High film strength, exceptional resistance to water, steam and other adverse conditions. Tan Cartridge 14.5 oz. 40/Case



293-L0096-098CASE
Formulated for higher temperature applications. They are shear stable, multi-purpose greases for both plain and anti-friction bearings. 14.5 oz. 40/Case



293-L0102-098
Heavy-Duty, General Purpose, Lithium Type Grease. This is an excellent, heavy-duty, general purpose, lithium type grease for both industrial and automotive applications. 14.5 oz cartridge - 40 Cart/Case



293-L0106-098
Multi-Purpose Grease. Highly water resistant and tacky, they are designed for applications where the grease is subjected to heavy pressure and shock loads. 14.5 oz cartridge – 40 Cart/Case



293-L0135-063C
Chain & Cable Fluid - Penetrating Oil. A superior, cleansing, non-gumming penetrating oil for wire rope, chains, cables and general lubrication. 12 oz. 12 Cans/Case



293-L0145-098
FML-2 Food Machinery Grease Anti-wear, anti-rust, anti-corrosion, and anti-oxidation additives. Used in the food processing industry for quick, clean applications 14.5 oz cartridge - 40 Cart/Case



293-L0149-063
X-357 - Extreme Pressure Lubricant An extreme pressure lubricant that penetrates and adheres. Water resistant and unaffected by temperature extremes. This product contains moly-disulfide For use on pintle hooks, slide axles, open gears, fifth wheels 11 oz can 12 Cans/Case



293-L0152-063C
Gear Shield Extra Heavy Lithium-Based, Extreme Pressure Lubricant. Developed for easy lubrication of open gears. A tough, tacky grease. Excellent for fifth wheel applications 11 oz.



293-L0161-098
High Temp Multi-Purpose, High Temperature, Bentone Type Grease. Multi-Purpose, for high temperature applications. Non-melt type, workable from 40°F / 4°C to 500°F / 260°C with frequent lube intervals 14.5 oz.



293-L0166-098
1552 Grease Gun Cartridge Multi-purpose lubricants can withstand higher temperatures than traditional lithium greases They provide high film strength, excellent shear stability, long lubricant life, and exceptional anti-wear properties 14.5 oz cartridge - 40 Cart/Case



293-L0167-098
LTR-2: Heavy-Duty, Tacky, Red, Lithium Complex Grease. This rugged, tacky, highly water resistant, extreme pressure grease can withstand higher temperatures than traditional lithium greases 14.5 oz cartridge - 40 Cart/Case



293-L0172-098
Low Temp Multi-Purpose Grease Multi-purpose, anhydrous calcium based grease for cold temperatures. Excellent multi-purpose low temperature grease. Anti-wear, anti-rust, anti-corrosion, and anti-oxidation properties 14.5 oz. cartridge 40 Cart/Case



293-L0189-098CASE
 These multi-purpose greases have a wide operating temperature range for variety of applications.
 14.5 oz cartridge
 40 Cart/Case



293-L0231-098
FGL-1 High Performance, Multi-Purpose, Aluminium Complex, Food Grade Grease
 14.5 oz. cartridge
 40 Cart/Case



293-L0232-098
FGL-2 High Performance, Multi-Purpose, Aluminium Complex, Food Grade Grease
 14.5 oz. cartridge
 40 Cart/Case



293-L0706-057
 Lubriplate® AC Series Air Compressor Oils Formulated to reduce carbon and varnish buildup. This air compressor fluid is ISO-68 1 Gallon Jug 4 Jugs/Case



293-L0707-057
 Fluid zinc Formulated to reduce carbon and varnish buildup ISO viscosity grade 100 Reduces heat and foaming. This air compressor fluid is ISO-100 and recommended for piston/reciprocating type air compressors
 1 Gallon Jug 4 Jugs/Case



293-L0713-054
 Air Tool Lubricant Designed for both rotary and reciprocating types of air tools Removes gumming and sludge Viscosity index 120 ISO viscosity grade 32 1 Gallon Jug 4 Jugs/Case



293-L0721-063
 Penetrant/Lubricant General Purpose. Penetrating and moisture displacement fluid designed to provide excellent protection against rust and corrosion. Will protect and preserve both ferrous and non-ferrous alloys, interior surfaces and surfaces open to the atmosphere. Biodegradable
 11 oz. can 12 Cans/Case



293-L0723-063
 Silicone Multi-Purpose Food Grade Lubricant. Film provides rust, corrosion and tarnish resistance * Wide operating temperature range 9.5 oz. can 12 Cans/Case



293-L0882-063CASE
FMO-350-AW Spray A multi-purpose, Anti-wear fortified, food machinery oil, in easy to apply spray can. For use where a Class H-1 oil is required.
 12 oz. Can
 12 Cans/Case

LUFKIN

182-L120PN

Lufkin 3/8" x 240" Artisan® Diameter Tape Measure Rugged, Vinyl-Covered Steel Case Chrome Clad® and Nubian® Blade .008" Thick Blade Large Easy Winding Drum and Friction Washers Blade Style: B12 Nylon roller, guides the tape smoothly in and out of the case

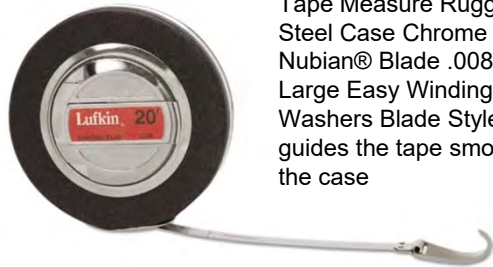

182-L616

Lufkin™® L616 3/4-Inch by 16-Foot Hi-Viz Orange Power Return Tape 2 rivet end hook with reinforcing strip. Case designed to fit comfortably in hand. Clear coat blade protection for more durable markings. Slide lock button allows for easy control of tape blade

182-L625

Lufkin Tape, Power, 1 In. X25', Hi-viz Orange 2 rivet end hook with reinforcing strip. Case designed to fit comfortably in hand. Clear coat blade protection for more durable markings. Slide lock button allows for easy control of tape blade. Wide Base Helps Keep Tape Standing Upright



182-PHV1048CME

Lufkin Tape, 1 In. X26' (25mmx8M), Hi-Viz Orange P1000 Series Bright yellow blade has clear easy-to-read numerals. Cushioned blade return. Fits easily into most tape holsters. Hi-Viz orange case is easy to find on the job. Removable belt clip. Rubber cushion case exterior protects tape from impact and improves grip. Toggle lock is positioned for convenient operation



LUMXL-1100-B
Utility Grease Gun
Entry-level. Offers Great Performance at an Economical Price. Cast-Alloy Head - Develops up to 10,000 PSI (690 Bar)
Handy 2-Way Loading: 14 oz. (397 g) Cartridge or 16 oz. (454 g) Bulk Fill



LUMXL-1120
Heavy Duty Deluxe Grease Gun. Providing more features for Professionals who demand a better Grease Gun for the punishing day-in and day-out service required by Industrial users.



LUMXL-1123
Heavy Duty Deluxe Grease Gun with 18" Flex Hose and Coupler. Heavy-Duty, LuCast, cast alloy head with heavier and reinforced wall thickness for extra strength. Develops up to 10,000 PSI (690 Bar). Handy 3-way loading fill with standard cartridge, suction or bulk fill.



LUMXL-1142
Heavy Duty Premium Grease Gun. Built to take Extreme Punishment. Ideal for Heavy-duty Lubrication, it is the toughest, most rugged and productive Grease Gun, available. Simply and positively the first choice of the Professionals.



LUMXL-1152
Heavy-Duty Deluxe Pistol Grease Gun with 18" Flex Hose extension for Hard-to-reach Fittings



LUMXL-1172
Mini-Pistol Grip Grease Gun with 3 Oz Cartridge. Compact and Lightweight



Part #	Description
LUMXL-1201	Grease Hose 12 1/8 NPT 4500 PSI Thermoplastic. Fully Bonded Construction to Maximize Kink Resistance and Minimize Bend Radius
LUMXL-1203	Grease Hose 18 1/8 NPT 4500 PSI Thermoplastic. Fully Bonded Construction to Maximize Kink Resistance and Minimize Bend Radius
LUMXL-1205	Grease Hose, 12", Spring, 1/8" NPT, 4500 PSI, Thermoplastic. Fully Bonded Construction to Maximize Kink Resistance and Minimize Bend Radius
LUMXL-1207	Grease Hose, Spring, 18", 1/8" NPT, 4500 PSI, Thermoplastic. One end has High Quality 1/8' NPT Male Thread Fitting and other end has Heavy Duty, High Quality 3/8"-32 UNEF Male Thread Fitting



LUMXL-1316
Heavy Duty Lever Action Barrel Pump. Designed for fast transfer of Non-Corrosive Fluids, such as, Heating Oil, Motor Oil, Transmission Fluid, Automotive Additives (Oil Based), Oils (Light and Heavy), Soaps, etc



LUMXL-1400
Standard Grease Coupler 1/8 NPT 1/Pk. For use with most Hand-operated Grease Guns and Air-Powered Equipment



LUMXL-3007-10
1/4"-28 Taper Thread (SAE-LT), Straight, 0.54". Fully hardened for extra durability and to protect them from wear due to constant use



Part	Description
470-1	1-3/4" Laminated Steel Lock Shackle 15/16" tall 5/16" Wide Keyed Different
470-1KA	1-3/4" Laminated Steel Lock Shackle 15/16" tall 5/16" Wide Keyed Alike: Multi locks 1 key
470-1KALF	1-3/4" Wide Laminated Steel Pin Tumbler Padlock with 1-1/2in Shackle, Keyed Alike
470-3	1-9/16" Laminated Steel Lock Shackle 3/4" tall Keyed Different
470-3KA	1-9/16" Laminated Steel Lock Shackle 3/4" tall Keyed Alike
470-3D	1-9/16" Laminated Steel Lock Shackle 9/32" tall 3/4" wide Keyed Different
470-5	2" Laminated Steel Lock Shackle 1" Tall, Keyed Different
470-5KA	2" Laminated Steel Lock, Shackle 1", Keyed Alike
470-7	1-1/8" Laminated Steel Lock, Shackle 9/16" Tall Keyed Different
470-7KA	1-1/8" Laminated Steel Lock Shackle 9/16" Tall Keyed Alike



Part	Description
470-410BLK	410 Black Thermoplastic Safety Padlock 1-1/2" Wide 1-1/3 Tall Key Different
470-410BLU	410 Blue Thermoplastic Safety Padlock 1-1/2" Wide 1-1/3 Tall Key Different
470-410GRE	410 Green Thermoplastic Safety Padlock 1-1/2" Wide 1-1/3 Tall Key Different
470-410RED	410 Red Thermoplastic Safety Padlock 1-1/2" Wide 1-1/3 Tall Key Different



140-DLF
1-9/16in (40mm) Wide Solid Brass Body Padlock with 1-1/2in (38mm) Shackle



Part	Description
470-416	Aluminum Lockout Hasp, 1in (25mm) Jaw
470-420	Safety Hasp, 1" Diameter Steel Jaw, Red
470-421	Safety Hasp, 1-1/2" Diameter Steel Jaw, Red



470-1175
Pro Series Set Your Own Combination Brass Lock. 2-1/4" wide solid brass body for superior corrosion resistance



Part	Description
470-6127KA	2-5/8" (67mm) Wide ProSeries® Weather Tough® Laminated Steel Rekeyable Pin Tumbler Padlock, Keyed Alike
470-6127KALH	2-5/8" (67mm) Wide ProSeries® Weather Tough® Laminated Steel Rekeyable Pin Tumbler Padlock with 2-1/2in (64mm) Shackle, Keyed Alike
470-6127KALJ	2-5/8" (67mm) Wide ProSeries® Weather Tough® Laminated Steel Rekeyable Pin Tumbler Padlock with 2-1/2in (64mm) Shackle, Keyed Alike



470-481
Gate Value Lockout fits 2"- 5" Handles



470-482
Gate Value Lockout fits 4"- 6.5" Handles



470-487
Electric Plug Cover Lockout, Small - 120/240V Plugs



470-491B
Grip Tight Circuit Breaker Lockout for wide or tall breaker toggles



470-493B
Grip Tight Circuit Breaker Lockout for standard size breaker toggles



470-498A
Portable Group Lock Box



CHEVRON™ Wiper/Scraper

- Decorative needlepunch V-pattern performs well in multi-directional traffic areas
- Surface made from 50% P.E.T. recycled fibre
- Premium vinyl backing provides a moisture barrier to help protect floors

Part	Description
MTC-15M31054	Chevron Mats 3Ft X 10Ft Charcoal (54)
MTC-15M3554	Chevron Mats 3Ft X 5Ft Charcoal (54)
MTC-15M4654	Chevron Mats 4Ft X 6Ft Charcoal (54)



GLACIER^{MC} Wiper/Scraper

- Dual fibre construction for well-balanced dirt scraping and water retention performance
- Vinyl backing provides moisture barrier to help protect floors
- Attractive mat that keeps entrance clean

Part	Description
MTC-GLM3654	Glacier All Purpose Mat 3Ft X 6Ft Charcoal/Black (54)
MTC-GLM4654	Glacier All Purpose Mat 4Ft X 6Ft Charcoal/Black (54)
MTC-GLM6654	Glacier All Purpose Mat 6Ft X 6Ft Charcoal/Black (54)



WEAR-BOND™ TUFF-SPUN®

Ideal solution for economical comfort and long-term durability

- Tough cast vinyl surface bonded to a PVC sponge
- 50% greater puncture resistance and five times the abrasion resistance than traditional sponge products

Part	Description
MTC-FL2436BK	Ergonomic Mats Tuff Spun 2Ft X 3Ft Black
MTC-FL3660BK	Ergonomic Mats Tuff Spun 3Ft X 5Ft Black



CHEVRON™ Wiper/Scraper

- Decorative needlepunch V-pattern performs well in multi-directional traffic areas
- Surface made from 50% P.E.T. recycled fibre
- Premium vinyl backing provides a moisture barrier to help protect floors

Part	Description
MTC-15M31054	Chevron Mats 3Ft X 10Ft Charcoal (54)
MTC-15M3554	Chevron Mats 3Ft X 5Ft Charcoal (54)
MTC-15M4654	Chevron Mats 4Ft X 6Ft Charcoal (54)



MAT-A-DOR™ Scraper

- Remains flexible and maintains performance in the coldest temperatures
- Contains 60% more « fingers » than standard fingertip mats, for outstanding scraping action
- Bevelled edge reservoir retains up to 1 gal. of liquid per sq. yd.

Part	Description
MTC-MAFG62BK	Mat-A-Dor 3Ft X 6Ft Black (Bk)
MTC-MASR42BK	Mat-A-Dor 2Ft X 2Ft 8In Black (Bk)



TERRA-NOVA^{MC} Wiper

- Attractive mat that keeps entrance clean
- Vinyl backing provides moisture barrier to help protect floors

Part	Description
MTC-TVM310ST	Terra-Nova Moderate Traffic Wiper Mat Mats 3Ftx10Ft Stone
MTC-TVM35ST	Terra-Nova Moderate Traffic Wiper Mat Mats 3Ftx5Ft Stone
MTC-TVM46ST	Terra-Nova Moderate Traffic Wiper Mat Mats 4Ft X 6Ft Stone





MKL42805EA
Oxytite PTFE thread sealant specifically formulated for oxygen services. Each batch of OXY-TITE is tested to the stringent standard of ASTM G-72
4 oz 6/Case



MKL80620EA
BL Blue 144 Per Case PAINTSTIK For fabricating structural steel, or layout work where the marks are required to bleed through a primer coat covering the marks. For marking under water-based primers use the BL-W Paintstik™. Marks bleed through solvent or oil-based paints. Real paint in stick form. To prevent bleeding through the finish coat, seal the marked areas with water-based epoxy paint

MKL61051EA White
MKL60153EA Yellow
Quik Stik Marker, Marks on virtually any surface. More marks for the money, 20% longer than other brands. Plastic holder with self storing cap prevents breakage, keeps hands and clothing clean. Smooth marking, fast drying paint marks dry in 5-7 minutes. Stick advances by turning twist up knob



MKL80220EA White
MKL80221EA Yellow
B Paintstik Marker Ideal for layout, color coding, fabrication and identification. Lead-free, non-toxic. Marks on any material, surface, or texture. Marks through oil and water. Real paint in stick form



MKL84621EA
Ball Paint Marker, Yellow, 1/8 in, Metal Ball Point Durable metal ball tip marks on smooth or rough surfaces. Lead-free, non-toxic. Marks are weather- and fade-resistant. Marks with real paint, dries in 5 minutes. Plastic cap keeps tip clean between jobs. Stores in pocket for easy access. Unbreakable plastic bottle with 1/8" steel ball tip



MKL96002EA
Silver Streak is are ideal when highly-visible, torch-resistant marks are required during metal layout and fabrication work. Flat Refill 24/Case (100 Refills In Each) Durable metal and plastic holders prevent breakage

Part #	Temperature
MKL86400EA	100F
MKL86463EA	150F
MKL86481EA	175F
MKL86517EA	200F
MKL86526EA	213F
MKL86544EA	225F
MKL86562EA	250F
MKL86625EA	300F
MKL86697EA	350F



Thermomelt™ Heat Stik™ markers are a quick, low-cost method to accurately measure surface temperatures of various metals and equipment. Available in 88 Fahrenheit and 32 Centigrade temperatures, the stick-in-holder design provides convenience and durability for long-lasting use in the workshop or in the field

Part #	Temperature
MKL86733EA	400F
MKL86769EA	450F
MKL86805EA	500F
MKL86841EA	600F
MKL86859EA	650F
MKL86868EA	700F
MKL86877EA	750F
MKL86886EA	800F
MKL86958EA	1100F



MKL96005EA
Red Riter Metal Marker Flat With Refill. Ideal for use on aluminum and stainless steel, Red-Riter metal markers deliver high visibility marks which are resistant to torch flames. The red lead is more visible through a welder's filter plate



MKL96006EA
Silver-Streak Round metal markers are ideal when highly-visible, torch-resistant marks are required during metal layout and fabrication work. The unique reflective lead is more visible through a welder's filter plate and will not rub, burn or blow off like soapstone. Marks on all metal surfaces including oily or wet



MKL96007EA
Silver Streak Round Refill 6 Pack. Durable metal and plastic holders prevent breakage. Holders include pocket clip. Ideal for doing metal layout and fabrication work. Marks on all types of metal surfaces. Marks won't rub off like soapstone



MKL96022EA

DURA-INK® 15 Red Felt Tipmarker. Durable plastic barrel and cap with pocket clip. The wear-resistant, fast-drying ink and durable tip and barrel makes this marker ideal for industrial environments



Valve Action Paint Marker is a fast-drying liquid paint marker that provides long-lasting, wear- and weather-resistant marks that are safe for almost any surface. As the most versatile liquid paint marker in the world, the xylene-free paint reduces user health risks and is available in 18 bold and fluorescent colors for accurate mark identification. Dura-Nib medium bullet tip resists wear to provide long marking life. Durable metal barrel and clip-cap reduce breakage and store easily in pocket. Marking range: -50°F to 150°F (-46°C to 66°C)



Part #	Colour
MKL96820EA	White
MKL96821EA	Yellow
MKL96822EA	Red
MKL96823EA	Black
MKL96825EA	Blue



MKL96023EA

Dura-Ink 15 Felt-Tip Marker Black Durable plastic barrel and cap with pocket clip. Fast-drying, xylene-free, industrial-strength ink. Great for part identification, layout work, quality control processes and, marking cartons and crates. Leaves smear-resistant, water-resistant marks



The **PRO-LINE** Fine and Micro liquid paint markers combine the durability of paint with the marking precision of fine, valve-actuated tips. Whether marking on small surface areas or where easily-readable marks are required, the small tip sizes provide highly-visible, sharp lines for greater mark identification.



PRO-LINE HP is a liquid paint marker developed for superior marking performance on oily and greasy surfaces. The high performance paint penetrates through oils and greases to dry quickly and leave a bold, permanent mark that is wear, weather, and fade-resistant.



MKL96101EA

Silver-Streak Woodcase Welder's Pencil Markal Silver-Streak and Red-Riter welders pencils make torch-resistant marks that will not burn or rub off like soapstone. Ideal for fine line marking during metal layout and fabrication, these highly visible marks illuminate when cutting or welding.

Part #	Description
MKL96872EA	PRO-LINE HP - Yellow
MKL96874EA	PRO-LINE HP - Red
MKL96675EA	PRO-LINE HP - Blue
MKL96876EA	PRO-LINE HP - Green

Part #	Description
MKL96960EA	PRO-LINE HP -White
MKL96961EA	PRO-LINE HP - Yellow
MKL96962EA	PRO-LINE HP - Red
MKL96963EA	PRO-LINE HP - Black



MKL96223EA

Dura-Ink Felt-Tip Markers, Black, 1/4 in, Felt Chisel tip makes fine lines or broad marks. Convenient pocket clip. Extra large ink supply for greater mileage. Fast-drying, xylene-free, industrial-strength ink. Great for part identification, layout work, quality control processes, sign making and marking cartons and crates. Leaves smear-resistant, water-resistant marks



469-600376420 W 9-125 Angle Grinder

Low fatigue as never before: compact angle grinder with smallest handle circumference in its class for perfect ergonomics. New, patent-pending Metabo Long life motor with up to 50% more torque and up to 20% higher overload capacity for quicker material removal and longer service life



469-613074620 WPB 18 LTX 115 Cordless Angle Grinder

Cordless Angle Grinder. ... 2x18V/5.5Ah LiHD; Charger ASC 30-36 V (110-120 V / 50 - 60 Hz); Plastic Carry Case. Unique encapsulated Metabo brushless motor with optimum protection from dust provides quick work progress and the highest efficiency. Slim design for prolonged comfort when working overhead or in areas with limited space.



469-600380420 WP 9-115 Quick (600380420) Angle Grinders

Low fatigue as never before: compact angle grinder with smallest handle circumference in its class for perfect ergonomics. New, patent-pending Metabo. Long life motor with up to 50% more torque and up to 20% higher overload capacity for quicker material removal and longer service life. Now even faster: Metabo Quick System for tool-free disc change at the touch of a button by means of quick flange nut

469-600552420 WEPBA 17-150 Quick 6" Angle Grinder

Maximum productivity: first 1,700 watt angle grinder with the power of a large grinder and the compactness of a small one for quickest material removal for industrial applications. New, patent-pending Metabo Long-life motor with up to 50% more torque and up to 20% higher overload capacity for quicker material removal and longer service life





495-2682-22
M18™ 5-3/8" Metal Saw (Bare Tool) Exclusive 4-Pole Frameless Motor delivers up to 35% more cutting power. Lightweight 4.3 lbs



495-2799-22CX
M18™ Compact Brushless Hammer Drill/Brushless Impact Combo Kit (2 Tool).
What's Included:
(1) M18™ 1/2" Compact Brushless Hammer Drill/Driver (2702-20)
(1) M18™ 1/4" Hex Brushless Impact Driver - TOOL ONLY (2750-20)
(1) M18™ REDLITHIUM™ 2.0 Compact Battery Pack (48-11-1820)
(1) M18™ REDLITHIUM™ XC 4.0 Extended Capacity Battery Pack (48-11-1840)
(1) Carrying Case



495-2603-22
M18 FUEL™ 1/2" Drill/Driver Kit. POWERSTATE™ Brushless Motor: Delivers up to 725 in lbs of torque. REDLITHIUM™ battery Technology. Includes: (2) Redlithium XC 4.0 batteries, multivoltage charger and case



495-2604-22
M18 FUEL™ High Capacity 1/2" Hammer Drill/Driver Kit. Powerstate™ Brushless Motor REDLITHIUM™ battery Technology. Includes: (2) Redlithium XC 4.0 batteries, multi-voltage charger and case



495-2720-22
M18 FUEL™ SAWZALL® Reciprocating Saw Kit. POWERSTATE™ Brushless Motor. Includes: (2) Redlithium XC 4.0 batteries, multivoltage charger, blade and carrying case



495-2763-22
M18 FUEL™ 1/2" High Torque Impact Wrench with Friction Ring Kit. POWERSTATE™ Brushless Motor. Includes: (2) M18 Redlithium XC 4.0 extended capacity, multi-voltage charger and carrying case



495-2780-22
M18 FUEL™ 4-1/2" / 5" Grinder, Paddle Switch No-Lock Kit. POWERSTATE™ Brushless Motor. Includes: (2) 18V XC high capacity Redlithium batteries, multi-voltage charger, carrying case., flange nuts, wheel guard, spanner wrench



495-6232-21
Deep Cut Variable Speed Band Saw Kit. Powerful 11 Amp Motor w/ CPT™: Provides maximum performance and durability



495-48-40-4515
Circular Saw Blade 8" 42 Tooth Dry Cut Cermet Tipped. This 8 in. 42 tooth blade is designed to cut a variety of ferrous materials 3/32 inch and thicker, including pipe, angle iron, steel studs and conduit. The blade has vibration damping which reduces heat, sparks and noise for cleaner smoother, burr free cuts. Use with Milwaukee Dry Cut Saw 6370-20



495-6370-21
13.0 AMP 8" Metal Cutting Saw Kit. Powerful 13.0 Amp 1-3/4 Max HP motor 3,700 RPM



495-6088-30
15 Amp 7 7/9" Large Angle Grinder w/ Lock-on.
What's Included:
(1) 15 Amp 7 7/9" Large Angle Grinder w/ Lock-on (6088-30)
(1) Flange
(1) Spanner Wrench
(1) Type 27 Guard



495-6232-20
Deep Cut Variable Speed Band Saw delivers 2X more durability, best-in-class power at 11 Amps, revolutionary cut visibility and the industry's largest cut capacity at 5" by 5"



MOTM-26
Sub-Micronic Compressed Air Filter Mount at point of use downstream of Motor Guard M-26/60 Filter. Removes oil vapor from air using activated carbon. The ultimate final filter for plasma cutters and other critical applications



MOTM-723
Filter Elements, M-723. For Use With M30.M60 Increases the efficiency and tip life of plasma cutter. Removes moisture and oil aerosols from compressed air line. Will isolate particles as small as .01 microns





The Nissen Feltip Paint Marker dispenses a fast-drying, high-gloss enamel paint for permanent marking, lettering, coding and numbering of both interior and exterior surfaces



NISPWHS – 00300 - 028770

Solid Paint Markers, White, 5/16 in, Standard Marks are permanent - will withstand heat and weathering. Marks can be easily removed from non-porous surfaces. Solid stick of paint protected by an unbreakable plastic case. Writes on any surface: rough/smooth/rusty, wet/oily/dry. Writes under water



NISPYES – 00301 - 028771

Solid Paint Markers, Yellow, 5/16 in, Standard Marks are permanent - will withstand heat and weathering. Marks can be easily removed from non-porous surfaces. Solid stick of paint protected by an unbreakable plastic case. Writes on any surface: rough/smooth/rusty, wet/oily/dry. Writes under water

NIFPWHM - 00350 - 096820
Feltip Paint Marker White



NISPRES – 00302 - 028772

Solid Paint Markers, Red, 5/16 in, Standard Marks are permanent - will withstand heat and weathering. Marks can be easily removed from non-porous surfaces. Solid stick of paint protected by an unbreakable plastic case. Writes on any surface: rough/smooth/rusty, wet/oily/dry. Writes under water

NIFPYEM – 0351 - 096821
Feltip Paint Marker Yellow



NISWPC – 06050 - 096102
Silver Welder's Pencil 3/Pack



NIMMWHM – 00201 - 096640
Metal Marker 1/8 White



NISPBKS – 00303 - 028773
Solid Paint Marker Standard Black



GEMINI RIGHTCUT

The re-engineered Norton Gemini RightCut 100% oxide wheels provide thinner, faster cutting with a burr-free, precision cut and improved operator comfort.

Enhance Performance and Life Up to 20% With Our Proprietary Zirconia Grain

Highly versatile product that grinds and cuts a variety of materials with efficiency: stainless steel, carbon steel, alloys to gray iron

"NEW" Type 1 GEMINI RIGHTCUT	Size	Type 27 GEMINI RIGHTCUT	Size
NTN66252823602	4-1/2 x .045 x 7/8	NTN66252842026	4-1/2 x .045 x 7/8
NTN66252823603	5 x .045 x 7/8	NTN66252842036	5 x .045 x 7/8
NTN66252823604	6 x .045 x 7/8	NTN66252842202	6 x .045 x 7/8

Blue Fire Fast Cut T 27 Grinding Wheel	Size
NTN66252843214	4-1/2 x 1/4 x 7/8
NTN66252843218	5 x 1/4 x 7/8
NTN66252843203	6 x 1/4 x 7/8



GEMINI XXL

The Fastest Grinding 100% Aluminum Oxide Wheels in the Market

- 50% more life and metal removal than standard aluminum oxide wheels
- Best on hard-grade carbon steel applications, weld repairs, flashing and any job that requires

Gemini XXL Type 27 Grinding Wheel	Size
NTN66252843784	4-1/2 x 1/4 x 7/8
NTN66252843786	5 x 1/4 x 7/8
NTN66252843788	6 x 1/4 x 7/8

Gemini XXL Type 27 (Pipefitter) Wheel	Size
NTN66253370271	4-1/2 x 1/8 (5/32)x 7/8
NTN66252842038	5 x 1/8 (5/32)x 7/8
NTN66252835580	6 x 1/8 (5/32) x 7/8

NORTON

Performance and Affordability 30%+ life versus competitive aluminum oxide flap discs.

Their versatility and economical initial price make Norton Neon flap discs ideal for shops with numerous requirements – from stock removal to blending. Good choice for soft metals to hard-to-grind stainless and carbon steel.



NEON Flapdisc T 27 Trimmable	Size	Grit
NTN66623399004	4-1/2 x 7/8	40
NTN66623399005	4-1/2 x 7/8	60
NTN66623399006	4-1/2 x 7/8	80
NTN66623399008	5 x 7/8	40
NTN66623399009	5 x 7/8	60
NTN66623399010	5 x 7/8	80

Premium Ceramic R980P Abrasive Grain

For the highest productivity on the toughest jobs, and for full use of the flaps, use Norton Blaze R980P premium ceramic abrasive flap discs. Latest-generation ceramic abrasive and durable. Y-weight polyester flaps are mounted on our easily-trimmable plastic back plate.



Blaze Flapdisc T 27 Trimmable	Size	Grit
NTN66254400253	4-1/2 x 7/8	40
NTN66254400254	4-1/2 x 7/8	60
NTN66254400255	4-1/2 x 7/8	80
NTN66254400262	5 x 7/8	40
NTN66254400264	5 x 7/8	60
NTN66254400265	5 x 7/8	80



K227 Shop Rolls
They tear cleanly and straight without shedding and are packed in a protective dispenser to eliminate waste and damage.

Shop Rolls K227	Size	Grit
NTN66261136179	1 x 50 Yards	P80-J
NTN66261136181	1 x 50 Yards	P120-J
NTN66261136182	1 x 50 Yards	P150-J
NTN66261136186	1 x 50 Yards	P180-J
NTN66261136192	1-1/2 x 50 Yards	P80-J
NTN66261136195	1-1/2 x 50 Yards	P120-J
NTN66261136196	1-1/2 x 50 Yards	P150-J
NTN66261136199	1-1/2 x 50 Yards	P180-J
NTN66261136204	2 x 50 Yards	P80-J
NTN66261136206	2 x 50 Yards	P120-J
NTN66261136207	2 x 50 Yards	P150-J
NTN66261136208	2 x 50 Yards	P180-J

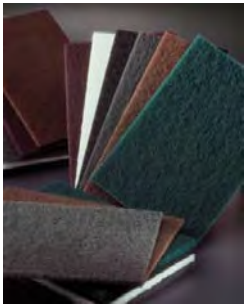

Surface finishing hand pads and rolls are made of a non-woven nylon web impregnated with abrasive grain and resin bond

Non Woven Hand Pad	Colour	Size	Grit
NTN66261074700	Maroon	6 x 9	747 General Purpose Pad
NTN66261069600	Light Green	6 x 9	696 Food Pro Pad



NorZon Plus

The Fastest Grinding Wheels in the Market

- Provides you with the lowest overall cost with the highest productivity
- Best on the hardest steels and wear resistant coatings and welds
- Made in our Texas, USA plant

NorZon Plus Depressed Center wheels	Size
NTN66252843328	4-1/2 x 1/4 x 7/8
NTN66252843334	5 x 1/4 x 7/8
NTN66252809376	6 x 1/4 x 7/8



OLFL-1

Ratchet Lock Utility Knife. Contoured handle includes a stainless steel blade channel and ratchet wheel blade locking mechanism



OLFLB-50B

18mm Snap-Off Blade - Olfa heavy-duty, snap-off replacement blades (LB) 50 blades/pack



OLFTK-4R

Multi-purpose Touch Knife - Color: Red
Stainless steel blade
Convenient hanging hole.
Also available in white, black, navy and yellow

OLFNL-A

18MM HD Cutters Rubber Grip Auto-lock Utility Knife



OLF180

9mm Standard Duty Cutters Multi-Purpose Metal Handle Utility Knife



OLFSK-4

Self-Retracting Safety Knife



ONG86622
Men's 16"
Economy Steel
Toe and
Midsole Boot
ATSM 2413-11
CSA - Green
Patch
Sizes 6-12



ONG89682
Steel Mid-Sole Men's
16 inch Economy
St/Sm Boot ATSM
2413-11
CSA - Green Patch
Sizes 6-12



562-094600-0000-245
9460, Remote Area Lighting System
Telescoping dual LED light heads,
Intelligent Control system, Gen 2, Yellow



562-019200-0000-110
1920B, LED Flashlight,
2-AAA, Gen 2, Black



562-026900-0100-110
2690 Headsup Lite LED Headlight
Z0, QPS/IEC Mining, Black



562-027550-0100-245
2755 LED Headlight 72 / 34 Lumen
Output Maximum Runtime: 15 Hours,
Yellow



562-1900-015-245
1900C, MityLite Flashlight-
2AAA, Yellow



562-1965-014-110
Mity-Lite 1965C LED
Flashlight 2AAA, Black



562-2300-010-110
Mity-Lite 2300 LED
Flashlight 2AA, Black



562-2340-010-245
2340C, MityLite Flashlight
+2AA, Yellow



562-2610-033-110
2610, HeadsUp Lite LED Headlight
3AAA, LEC/ETL, Black



562-1200-000-110
1200 Case Watertight, Crushproof
and Dustproof, Ext (27 x 24.6 x 12.4 cm)
WI/WF, Black



562-1400-000-110
1400 Case, Watertight,
Crushproof and Dustproof
Ext.(33.9 x 29.5 x 15.2 cm)
WI/WF, Black



562-1450-000-110
1450 Case, Watertight,
Crushproof and Dustproof
Ext.(42 x 33.1 x 17.4 cm)
WI/WF, Black



577-J2336
Gasket And Carbon Scraper 1-1/2" Angled blade for access into tight areas. Comfortable, four sided handle



577-J7318h
Proto® 1/2" Drive Deep Impact Socket 9/16" - 6 Point are ideal for use on stubborn or damaged fasteners, and also on fasteners made from soft materials.



577-J1200R-MASD
Proto® 18 Piece Satin Metric Combination ASD Wrench Set - 12 Point Satin finish provides corrosion resistance and a slip-resistant grip



577-J48007
Proto® 7 Piece Super-Duty Pin Punch Set. Made from S2 steel and specially heat-treated for greater strength and durability. Reverse taper to help prevent binding



577-JSCV-20S
Proto® 20 Piece Black Chrome Reversible Combination Ratcheting Wrench Set – Spline. Black chrome finish is corrosion resistant and visually distinctive



577-J209G
Proto® Heavy-Duty Diagonal Cutting Pliers - w/Grip 7-5/16". Induction hardened cutting edge. Powerful leverage cuts heavy wire with ease



577-J712G
Proto® Cushion Grip Adjustable Wrench 12". Soft cushion grip for additional comfort. Extra wide jaw capacity



577-J5220XL
Proto® 3/8" Drive 29 Piece Metric Socket, Combination Set - 6 Point. Proto® 6 Point Sockets are ideal for use on stubborn or damaged fasteners, and also on fasteners made from soft materials



Proto® Satin XL Combination Wrench
Satin finish provides corrosion resistance and a slip resistant grip. For use on extra large fasteners. Used in Mining, Oil & Gas, Industrial Construction. Forged heads with machined openings. 12 point box end allows for fine indexing, helping to improve speed and access. Fits 4, 6 and 12 point. Box end is countersunk for easy application to the fastener



Part	Description
577-J364	Large Retaining Ring Pliers - Internal 16-1/2" replaceable tips in 0°, 45° and 90°
577-J365	Large Retaining Ring Pliers - Internal 16-1/2" replaceable tips in 0°, 45° and 90°



577-J6013C
1/2" Drive Fixed Head Micrometer Torque Wrench 50-250 ft-lbs. Calibrated to +/- 4% clockwise direction and +/- 6% counter clockwise at 20% to 100% of full scale. Manufactured to meet standard industrial torque applications, general industry, heavy equipment, and maintenance



577-J9500A
Proto® 5 Piece Screw Extractor Set Drive into end of broken pipe or fitting. Use tap holder or wrench on extractor to turn out broken part
577-J9500B
Proto® 10 Piece Screw Extractor Set

577-J4900A
Proto® 3/8" & 1/2" Drive 10 Piece Hex Bit Set. Includes blow molded box. Proto® bits are offered in a broad range to accommodate production assembly applications. Made of alloy steel. Polished chrome finish

RLCTW7450LP
Spring Retractable Gas Welding Hose Reel have an independent dual swivel body manufactured from aluminum and hard coated for wear resistance. This unique design assures positive separation of gases. Double-sealed, special molded O-rings prevent leakage. Swivel body and inlet are both permanently identified with machined grooves on the acetylene side to assure proper installation. *For oxygen / acetylene only



RLCT122504
1/4 Twin Hose Safe-T-Reel. Reelcraft's Safe-T-Reel Series is ideal for applications where space, weight and flexibility are key. These reels are designed for manual winding of air/water/fuel gas hose, electric cord and welding cable



Portable Tristand® Vises

Each TRISTAND pipe vise features integral folding legs for easy transport and setup, tool hangers and a base which overhangs the front legs for clear tool swing

Part #	Model #	Description	Pipe Capacity in.
632-40130	40-A	Portable TRISTAND® Yoke Vise	1/8 - 2 1/2
632-16703	425	Portable TRISTAND® Chain Vise	1/8 - 2 1/2
632-36273	460-6	Portable TRISTAND® Chain Vise	1/8 - 6
632-36278	460-12	Portable TRISTAND® Chain Vise	1/8 - 12

Straight Pipe Wrench

Straight Pipe Wrenches have a sturdy, cast-iron housing and an I-beam handle with a full floating forged hook jaw, featuring self-cleaning threads with replaceable hook and heel jaws



Part #	Description
632-31005	Wrench, 8 RIDGID HD
632-31010	Wrench, 10 RIDGID HD
632-31020	Wrench, 14 RIDGID HD
632-31025	Wrench, 18 RIDGID HD
632-31030	Wrench, 24 RIDGID HD

Aluminum Pipe Wrenches

RIDGID® Aluminum Pipe Wrenches provide professional strength in lightweight aluminum. The Aluminum Straight Pipe Wrench offers the same durability and ease-of-use found in all RIDGID heavy-duty wrenches.



Part #	Dimensions
632-31090	10" Long, 1 1/2" Jaw Capacity
632-31095	14" Long, 2" Jaw Capacity
632-31100	18" Long, 2 1/2" Jaw Capacity
632-31105	24" Long, 3" Jaw Capacity
632-31110	36" Long, 5" Jaw Capacity
632-31115	48" Long, 6" Jaw Capacity



Power Pipe Cutter 632-50767

Cutter, 258 2-1/2-8 inch Pipe



Part #	Description
632-14218	Bolt Cutter, S18
632-14223	Bolt Cutter, S24
632-14228	Bolt Cutter, S30

Model 300 Power Drive Complete



Features

- RIDGID® speed chuck.
- Reversible 1/2 HP universal motor.
- Ideal for use with RIDGID roll groovers

Part #	Description	Spindle Speed RPM	Pipe Threading Capacity	
632-15682	300 Complete	115V, 50/60 Hz (NPT)	38	1/8" - 2"
632-15722	300 Complete	115V, 50/60 Hz (NPT)	57	1/8" - 2"
632-97415	300A Complete	230V, (NPT) Export	38	1/8" - 2"
632-97420	300A Complete	230V, (BSPT) Export	38	1/8" - 2"

Heavy-Duty Pipe Cutter

632-32820 Extra-long shank protects adjustment threads, while an extra-large handle is provided for quick, easy adjustment, 2-A-3 Wheel Heavy Duty



Tubing & Conduit Cutter

632-32940 Model # 30 Clean, square cuts are easily made on copper, brass, aluminum and thin-wall conduit

Pipe Dies for Machine Die Heads



Part #	Die Material or Type	NPT Nominal Pipe Size-Threads Per Inch
632-47765	High-Speed RH	1/2"-3/4"-4"-14
632-47770	High-Speed RH	1"-2"-11"-12
632-47785	H.S. For Stainless Steel RH	1/2"-3/4"-4"-14
632-47790	H.S. For Stainless Steel RH	1"-2"-11"-12



Part	Description
632-70830	Oil, 1 Gal Dark Threading
632-70835	Oil, 1 Gal Nuclear Threading
632-41600	Oil, 5 Gal Dark Threading



V-Head High Pipe stand



Roller Head High Pipe stand

Pipe Stands

A full range of heavy-duty adjustable pipe stands are available in varying configurations with capacity from 1/8"-36" (3 mm-900 mm). These stands are ideal for use while threading, welding or roll grooving pipe. Locking ring allows for quick vertical height adjustments

Part #	Model #	Description	Height Adjustment Low-High		Max. Pipe Capacity		Max.Weight Capacity		Weight	
			in.	cm	in.	mm	in.	mm	lb.	kg.
632-56662	VJ-99	V-Head High Pipe stand	20-38	51-96	12	300	2500	1134	32	14.5
632-22168	VF-99	V-Head High Folding Pipe stand	28-52	71-132	12	300	2500	1134	24	10.9
632-56672	RJ-99	Roller Head High Pipe stand	32-55	82-140	12	300	1000	454	27	12.3

632-41935

Model 700 Power Drive/Hand Held Threader, 1/8 in to 2 in Pipe Capacity Body: Cast aluminum. Designed for RIDGID No. 12R die heads. Features reversible 115V universal motor. Gear Head: All-spur gear reduction, spring loaded adapter pawl, hardened steel spindle gear. Switch: Double-throw reversible switch



632-23488

Scissor-Style Plastic Pipe & Tubing Cutter. X-CEL® blade – Quick change, reversible blade provides two times blade life. Spring loaded handles for faster positioning



632-30088

Ratcheting Plastic Pipe and Tubing Cutters, Aluminium Easy turn-thumb latch for reliable storage. Ergonomic grips on bottom handle are spaced at 1/2" increments to act as a quick pipe measuring scale. X-CEL™, quick change blade



632-97065

NPT Die Head Quick-Open R.H. Machine Universal Die Head Quick-Opening All die heads are through-head oiling

632-10883

Model 418 Hand Held Oiler An ergonomic 2-finger trigger design that reduces user fatigue. Die cast heavy duty body with swivel nozzle with no exposed parts for longer life. Twist and lock drip pan that easily locks in place



632-31320

Tool Length Chain. Heavy-Duty Chain Wrench Double jaw gives fast, ratchet-like action in either direction. Heavy-duty model has replaceable alloy steel jaws. Light-duty model has a one piece forged alloy steel handle and jaw

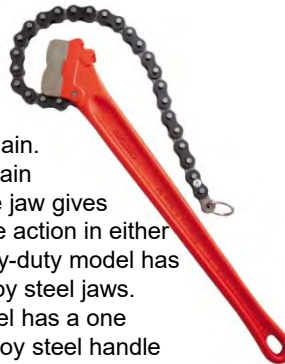

632-30118

Ratchet with Handle For Use With Model 12R, 6 lb Die heads snap in from both sides and lock in place. Durable ratchet-and-handle set. Ratchet knob indicates forward and reverse

Part #	Description
632-31320	C18 Chain
632-31325	C24 Chain
632-31330	C36 Chain

RUST-OLEUM®



High Performance®		
V2100 System Rust Preventive Enamel Aerosol		
Part	Description	Size
647-V2124838	Safety Blue	20 oz.
647-V2143838	Safety Yellow	20 oz.
647-V2155838	Safety Orange	20 oz.
647-V2163838	Safety Red	20 oz.
647-V2177838	Semi-Gloss Black	20 oz.
647-V2178838	Flat Black	20 oz.
647-V2179838	Black	20 oz.
647-V2190838	Flat White	20 oz.
647-V2192838	Gloss White	20 oz.



647-V2169838
V2100 System
Rust Preventive
Enamel Primer
Aerosol
Red Primer 20 oz.

647-V2182838
V2100 System
Rust Preventive
Enamel Primer
Aerosol
Gray Primer 20 oz.



647-2348402
2300 System <100 VOC
Traffic Zone Striping Paint
Yellow 1 Gal.



High Performance®		
V7400 System <340 VOC DTM Alkyd Enamel		
Part	Description	Size
647-245387	Flat Black	1 Gallon
647-245533	Flat White	1 Gallon
647-245403	High Gloss Black	1 Gallon
647-245406	High Gloss White	1 Gallon
647-245479	Safety Yellow	1 Gallon

647-V7086402
V7400 System <340 VOC DTM
Alkyd Enamel Primers
Quick Dry Gray Primer 1 Gallon

647-V769402
V7400 System <340 VOC DTM
Alkyd Enamel Primers
Quick Dry Red Primer 1 Gallon



647-276119
Pre-Paint & Cleaning
Wipes
90 Wipes/Container



647-275918
NeverWet™ Base
and Topcoat Kit



Industrial Choice®		
M1400 System Water-Based Construction Marking Paint Aerosol		
Part	Description	Size
647-264692	White	20 oz.
647-264696	Safety Red	20 oz.
647-264702	Fluorescent Pink	20 oz.
647-264694	Caution Blue	20 oz.
647-264695	Hi Visibility Yellow	20 oz.
647-264699	Fluorescent Red Orange	20 oz.
647-264700	Fluorescent Green	20 oz.
647-264693	Clear	20 oz.
647-264697	Fluorescent Orange	20 oz.
M1400 Solvent Based Construction Marking Paint		
647-331774	Clear	17 oz.
647-331775	White	17 oz.
647-331776	Caution Blue	17 oz.
647-331777	Hi Vis Yellow	17 oz.
647-331778	Safety Red	17 oz.
647-331779	Fluorescent Orange	17 oz.



647-1667830
1600 System General
Purpose Enamel
Primer Aerosol
Red Primer 16 oz.

647-1680830
1600 System General
Purpose Enamel
Primer Aerosol
Gray Primer 16 oz.



647-1685830
1600 System
Galvanizing
Compound Aerosol
Cold Galvanizing
Compound
16 oz.



Industrial Choice®		
M1600 System Solvent-Based Precision-Line Inverted Marking Paint Aerosol		
Part	Description	Size
647-203024	Caution Yellow	20 oz.
647-203025	High Visibility Yellow	20 oz.
647-203027	Fluorescent Orange	20 oz.

647-203036
M1800 System Water-
Based Precision-Line
Inverted Marking Paint
Aerosol Fluorescent
Orange 20 oz.





647-306513
Wet Tree Marking
Paint-Blue



647-306518
Wet Tree Marking
Paint-White



647-297200
COMM 5G
Shop Coat
Primer Red



647-305372
COMM 50G Shop
Coat Primer Red



647-288395
InstaPatch®
Concrete Repair
Gray 16 oz. Kit

647-276981
InstaPatch®
Concrete Repair
Gray 1 Gal. Kit

GripAll® LavaRung® Anti-Slip Ladder Rung Covers

LavaRungs® consists of multiple layers of silica aggregate embedded in durable polyurea. Rung traction control. Designed specifically for round ladders and scaffolding rungs.

Part	Description	Qty/Case
647-10LRBK1202	10 Pack LavaRungs Black 12" X 2"	4
16470LRYL1202	10 Pack LavaRungs Yellow 12" X 2"	4

GripAll® LavaGrip® Anti-Slip Adhesive Strips

LavaGrip® consists of multiple layers of silica aggregate embedded in durable polyurea. It is designed with safety and comfort in mind. Superior traction control. Textured surface for sure footing, yet is still comfortable to kneel on or walk across with bare feet

Part	Description	Qty/Case
647-10STLKBK02	10 Pack LavaGrip® Black 2"X24"	6
647-10STLYL02	10 Pack LavaGrip® Yellow 2"X24"	6
647-10STLKBK05	10 Pack LavaGrip® Black 5"X24"	6
647-10STLYL05	10 Pack LavaGrip® Yellow 5"X24"	6
647-LGBK0248	Single Pack LavaGrip® Black 2" X 48"	12
647-LGYL0248	Single Pack LavaGrip® Yellow 2" X 48"	12
647-LGBK0648	Single Pack LavaGrip® Black 6" X 48"	4
647-LGYL0648	Single Pack LavaGrip® Yellow 6" X 48"	4
647-LGBK1248	Single Pack LavaGrip® Black 12" X 48"	2
647-LGYL1248	Single Pack LavaGrip® Yellow 12" X 48"	2

GripAll® XtremeGrip® Studded Anti-Slip Adhesive Strips

XtremeGrip® consists of rust resistant studs in offset rows embedded in high-friction polyurea. Aggressive traction control. The patented stud design defeats debris that compromises traction, such as mud, wet leaves, grass clippings, oil/fluids, snow/ice, and other industry specific contaminants

Part	Description	Qty/Case
647-2STXBK02	2 Pack XtremeGrip® Black Stair Treads 2"X24"	10
647-2STXYL02	2 Pack XtremeGrip® Yellow Stair Treads 2"X24"	10
647-2STXBK05	2 Pack XtremeGrip® Black Stair Treads 5"X24"	6
647-2STXYL05	2 Pack XtremeGrip® Yellow Stair Treads 5"X24"	6
647-XGBK0224	10 Pack XtremeGrip® Black 2"X24"	6
647-XGYL0224	10 Pack XtremeGrip® Yellow 2"X24"	6
647-XGBK0524	10 Pack XtremeGrip® Black 5"X24"	6
647-XGYL0524	10 Pack XtremeGrip® Yellow 5"X24"	6
647-XGBK1224	10 Pack XtremeGrip® Black 12" X 24"	1
647-XGYL1224	10 Pack XtremeGrip® Yellow 12" X 24"	1



253-91930
SCRUBS® Stainless Steel Cleaner Towels clean, polish, brighten and protect all in one step. This powerful formula prevents water marks and corrosion and preserves the high luster of stainless steel



253-42272
SCRUBS® Hand Cleaner Towels combine an advanced cleaning formula with a strong, dual-textured towel to thoroughly clean hands and surfaces ANYWHERE, ANYPLACE, ANYTIME!® The clean, citrus-scented formula loosens and dissolves industrial soils while leaving hands free from dryness and irritation



SCRUBS® Graffiti and Paint Remover Towels combine a high-quality graffiti remover formula with an absorbent, abrasive, non-scratching towel. This product will loosen and remove graffiti and spray paint, allowing the towel to absorb and hold residue without re-depositing paint on surface.

253-90130 - SCRUBS® Graffiti & Paint Remover Towels
253-90891 - SCRUBS® White Board Cleaner Wipes





Professional grade, double-sided containment tape used for creating high-performance containment systems for restoration, abatement and remodeling tasks such as painting, cleaning, sanding, mold remediation, asbestos removal and more DS 154

689-104333RL CDA-48mm X 25yd-24 Rolls/Case 8.5 Mil



ShurGRIP® utility grade cloth duct tape for non-critical, general use applications, including packaging, bundling, sealing, repairing, holding and waterproofing. This economical, co-extruded solution offers good conformability and easy handling to prevent it from twisting or curling during application PC460

689-120954RL SIL-48MM X 55M-24 RLS/CS-H 6 mil

689-156710RL SIL-72MM X 55M-16 RLS/CS-H 6 mil



Economy grade fiberglass reinforced strapping tape for light duty strapping, packaging, bundling and palletizing applications. GS 490 offers good adhesion, quick stick and shock resistance for a range of tasks

689-101229RL Clear-18MM X 55M-48 RLS/CS-H/A 4.5 mil

689-101219RL Clear-24MM X 55M-36 RLS/CS-H/A 4.5 mil

689-101230RL Clear-48MM X 55M-24 RLS/CS-H/A 4.5 mil



General purpose grade hot melt packaging tape for manual or automated industrial sealing of lightweight cartons with minimal exposure to handling, shipping and load stress. HP 100® is engineered with an aggressive, high-tack adhesive and excellent holding power to keep carton seals intact

689-207142RL Clear-48MM X 100M-36 RLS/CS-S 1.6 mil

689-207194RL HP 100 Clear-72MM X 100M-24 RLS/CS-S 1.6 mil



20 Gallon Spill Kit - HazMat

Kit contains:

- 50 sorbent pads
- 4 sorbent socks
- 2 sorbent pillows
- 1 disposal bag
- 1 pair gloves
- 1 pair goggles



Small Vehicle Spill Kit .

Kit contains:

- 20 sorbent pads
- 2 sorbent socks
- 2 sorbent pillows
- 1 repair putty
- 1 pair gloves
- 1 pair goggles
- 2 disposal bags

Part #:SPKCSK21 – Oil Only

Part #: SPKCSK21U – Universal



CAMO SPILL KIT

Contents Include:

- 20 Oil Only Pads
- 10 Universal Pads
- 3 Universal Socks (4')
- 1 Plug N'dike With Antifreeze
- 2 Disposal Bags
- 1 Pair Goggles
- 1 Pair Gloves

Part #: SPKCSKCAMO



Soak-up and contain spills to keep fluids from spreading into larger areas and becoming slippery hazards.

Oil only sorbents (white) contain and soak-up petroleum-based fluids while repelling water. Universal sorbents (grey) are designed to pick-up aggressive hydrocarbon (oil and water) spills as well as non-aggressive acids, caustics, coolants, solvents and solutions Pads are perforated for easy use.

OIL ONLY PADS

SPKP100 - Oil Only Sorbent Pads Weight: Heavy Size: 15"x18" 100/bale

SPKEP100 - Oil Only Sorbent Pads Weight: Medium Size: 15" x 18" – 100/bale

UNIVERSAL PADS

SPKUP118-9 (medium weight) – 15" x 18" – 100/bale



STANLEY®



576-33-716
Fatmax™ 16' X 1-1/4" Tape Rule 11 ft blade standout BladeArmor™ coating for 10X* blade life. Mylar® polyester film extends life of entire blade. Tru-zero end hook for accurate measurements



576-33-725
Fatmax™ 25' X 1-1/4" Tape Rule is extra tough and durable thanks to industrial-grade BladeArmor™ coating on the first 4 1/2 feet and a high-impact ABS case



576-10-707
7-1/4 in Ergonomic Retractable Utility Knife. Robust all-metal construction, a narrow nose for accurate cuts and a comfortable thumb rest



576-89-865
9-1/2 in FATMAX® High-Leverage Linesman Pliers. High-leverage pivot design uses less energy to cut than traditional cutting pliers. Precision machined jaws ideal for gripping, twisting and cutting



576-42-465
9 in Magnetic Cast Aluminum Torpedo Level. Durable, heavy-duty, cast aluminum frame. Features large, top-read vial window. Tinted 360° vials make reading easy on the eyes. Pipe groove enables use on rounded surfaces



576-10-143P
18mm Retractable Pocket Cutter Light-duty, retractable cutter with Quick-Point™ Snap-Off Blades. Blade sections snap off providing a fresh, sharp cutting point



576-019151M
18-1/4 in Series 2000 Toolbox with Tray. Tool storage is made easy with the Stanley 19" 2000 Series tool box. It has 2 lid organizers for small parts storage that can be accessed without opening the lid as well as a tote tray inside



576-11-921A
100 pack 1992® Heavy-Duty Utility Blades with Dispenser. These high carbon steel blades are designed for general purpose cutting and a long cutting life



576-46-222
12 in Combination Square is durable and accurate. Its blade is made of hard chrome, which is coated to resist rust for long life. With built-in scribe for surface marking, easy-to-read vial, and die-cast metal handle, this tool allows for efficient measuring and marking



576-33-158
5m/16 ft PowerLock® Tape Rule. Mylar® polyester film extends life of entire blade. Chrome high-impact ABS case is job site tough



STM45107
Litebox Vehicle Mount System Orange. 90 degree swivel head. Durable construction with rubberized impact bumper. Easy-to-use toggle switch. Lens ring and cushioned grip handle



STM44450
Fire Vulcan® LED Standard System with AC/DC. Orange Deep dish parabolic reflector produces a tight beam with optimum peripheral illumination. 8 modes of operation Run time 3 hours. Waterproof



STM61200
3AA HAZ-LO® Division 1 Headlamp Three "AA" alkaline batteries (included). Rubber & Elastic Straps. Yellow. Parabolic reflector produces long range brilliance and smooth uniform beam pattern



STM66118
Stylus Pro® Alkaline Battery-Powered LED Pen Light – Black Corrosion & water resistant, machined aircraft-grade aluminum alloy, Type II MIL-Spec anodize plating. Available in black, red, silver, and blue



STM68244
4AA Luxeon With White LED Yellow With Batteries. Virtually indestructible, non-conductive polymer which features a rubber face cap for impact and shock resistance. Waterproof, safety approved. Wrist lanyard connection



STM74301
Strion® LED Flashlight. Multi-function, push-button tactical tail switch lets you select three lighting modes and strobe. C4® LED technology, impervious to shock with a 50,000 hour lifetime. Lithium ion battery is rechargeable up to 1000 times; fully recharges in 3 hrs



STM75810
Stinger® LED Flashlight. Super Bright, Multi-Purpose Rechargeable LED Multi-function On/Off push-button switch lets you choose three lighting modes and strobe; designed for extremely long life

SUMNER

SUMNER MANUFACTURING COMPANY INC.



SUM781235
Qwik Pin Flange Pins. Quick installing pins work as convenient reference points to level flange for tack and weld-out no tools needed



SUM780443
Pro Roll With Rubber Wheels. Clean and simple design avoids welder interference. Fast adjustment for easy pipe positioning. Roller adjustment from either side



SUM781300 Vee Head
SUM781301 Roller Head
Standard Hi Fold-A-Jack Stand 2500 lbs Capacity. Quick action lock washer for fast height positioning. Set screw can lock jack head to stand for transportation - no loose pieces



ULM1830
5 7/16" Pocket Scriber, Straight Point All-in-one "Push-Click" Safety Cover on Tungsten Carbide with Magnetic Pick-up. Sharp tungsten carbide tip cuts into hard surfaces, leaves clear mark on metal, glass, plastics and tools



ULMHT-3
Hi-Tech Magnetic Pick-Up Tool with Powercap® Magnet 10 lb. Comfortable textured cushion grip keeps handle secure even in wet or oily hands. Pocket clip keeps it handy and secure. Stainless steel telescoping handle is strong, long and lightweight



ULMHTC-2
High Tech Telescoping Inspection Mirror 2 1/4 All-angle ball joint holds mirror firmly for 360° viewing. Clear glass mirror for perfect reflection. Comfortable textured cushion grip keeps handle secure even in wet or oily hands. Mirror encased in rugged corrosion-resistant brushed stainless steel. Stainless steel telescoping handle is strong, long, and lightweight



ULMHTE-2
Inspect Mirror 1 1/4" All-angle ball joint holds mirror firmly for 360° viewing. Clear glass mirror for perfect reflection. Comfortable textured cushion grip keeps handle secure even in wet or oily hands. Mirror encased in rugged corrosion-resistant brushed stainless steel. Stainless steel telescoping handle is strong, long, and lightweight



ULMA-2T
Pocket Telescopic Inspection Mirror. 7/8" mirror diam. All-angle ball joint holds mirror head firmly at any angle for perfect viewing.



ULMHTS-2
Inspect Mirror 3 1/4 All-angle ball joint holds mirror firmly for 360° viewing. Clear glass mirror for perfect reflection. Comfortable textured cushion grip keeps handle secure even in wet or oily hands. Mirror encased in rugged corrosion-resistant brushed stainless steel. Stainless steel telescoping handle is strong, long, and lightweight

ULMSW-10
Swinger Pick & Hook



WD-40® Multi-Use product protects metal from rust and corrosion, penetrates stuck parts, displaces moisture and lubricates almost anything. It even removes grease, grime and more from most surfaces.

780-01005	WD-40 155g 12/Case
780-01011	WD-40 311g 12/Case
780-01003	WD-40 411g 12/Case
780-01010	WD-40 3.785L 4/Case
780-0204	WD-40 18.9L Pail



780-01032
WD-40
311g Big Blast
12/Case



780-01032
WD-40
408g EZ-Reach
12/Case





WB10026

Knot Wire End Brush, 3/4", 0.02 in Wire, Steel (EBB-40) Hollow-end wire brush. Ideal for cleaning in recessed areas. Rugged knot-type construction provides aggressive, high-impact action for severe applications



WB10028

Knot Wire End Brush, 1 1/8", 0.02 in Wire, Steel (EBB-41) Hollow-end wire brush. Ideal for cleaning in recessed areas. Rugged knot-type construction provides aggressive, high-impact action for severe applications



WB10217

Knot Wire End Brush Diameter 1/2"

Part #	Description
WB08756	Roughneck 5" Root Pass Weld Cleaning Brush, .020" Steel Wire Fill 5/8"-11 UNC Nut
WB08766	Roughneck 6" Stringer Bead Wheel, .020" Steel Wire Fill 5/8"-11 UNC Nut
WB08776	Roughneck Jr. 6" Filler Pass Weld Cleaning Brush .023" Steel Wire Fill, 5/8"-11 UNC Nut
WB08796	Roughneck 6" Filler Pass Weld Cleaning Brush .023" Stainless Steel Wire Fill, 5/8"-11 UNC Nut
WB08806	Roughneck 4-7/8" Root Pass Weld Cleaning Brush .020 Stainless Steel Wire, 5/8"-11 UNC Nut
WB08916	Roughneck 6" Filler Pass Weld Cleaning Brush, .023" Steel Wire Fill, 5/8"-11 UNC Nut
WB09400	Roughneck 6" Root Pass Weld Cleaning Brush, .020" Steel Wire Fill, 5/8"-11 UNC Nut
WB09500	Roughneck 6" Root Pass Weld Cleaning Brush, .020" Stainless Steel Wire Fill, 5/8"-11 UNC Nut
WB09856	Roughneck 5" Filler Pass Weld Cleaning Brush, .023" Steel Wire Fill, 5/8"-11 UNC Nut



WB13120

4" Standard Twist Wire Wheel, .020, 5/8"-11 A.H. (STA-4) Heavy-duty brushing action with some flexibility. Rugged knot-type construction provides aggressive, high-impact action for severe applications



WB13131

4" Roughneck Stringer Bead Wheel, .020, 5/8"-11 Constructed from premium quality wire. Effectively reaches into corners. Eliminates knot movement resulting in the most effective cleaning action, smoothest operation, and longest wheel life. Narrow face brush is suitable for cleaning root and hot passes



WB13156

3-1/2" Single Row Knot Wire Cup Brush, .023" Steel Fill, 5/8"-11 UNC Nut. Provides Heavy-Duty Brushing Action with Some Flexibility. Ideal for Demanding Cleaning Applications on Relatively Flat Surfaces



WB35315

3" Polyflex Encapsulated Stem-Mounted Crimped Wire Wheel, .0118" Steel Fill, 1/4" Stem. Burgundy elastomer gradually wears exposing consistent short trim for maximum aggression and long life



WB44075

Small Hand Wire Scratch Brush, Stainless Fill, Plastic. Also used with inert arc aluminum welding. For general cleaning in the plating, metal finishing, aircraft and missile industries



WB50923

2" BobCat Mini Flap Disc Angled Style Type 29, 4 oz. Type S Mount. Used on right angle air die grinders for smooth grinding and enhanced conformability. Small size allows access to combined areas



WB79805

Dually Stringer Bead Wheels, 6", .020 Steel Wire Delivers fast and effective cleaning action. Features a one-piece dual hex-nut that eliminates interference issues and simplifies periodic flipping of the wheel for maximum cutting action, longer life and safer use. Up to the task for the most demanding multi-pass welding applications



WB83150

8" Crimped Filament Nylox Wheel, .040/80SC Fill, 2" Arbor Hole



Type IA Fiberglass Step Ladder

The Fiberglass Ladder has a duty rating of 300 pounds and feature oversized, molded Proguard Boot™ for firm slip-resistant footing. These boots also protect the fiberglass rail. The HolsterTop® has the Lock-In System to keep your tools secure and right at your fingertips

- WRN6104CA – 4 feet**
- WRN6106CA – 6 feet**
- WRN6110CA – 10 feet**



Type I Fiberglass Step Ladder

The 6006CA Fiberglass Step Ladder features a HolsterTop with the Lock-In System that allows you to customize your ladder top. The system secures tools from falling while keeping them handy while working increasing productivity on the job. The tops also hold tools and have a sturdy paint can hanger on the back side

- WRN6004CA – 4 feet**
- WRN6006CA – 6 feet**
- WRN6008CA – 8 feet**

IA Aluminum Step Ladder

The 374CA Aluminum Step Ladder has a duty rating of 300 pounds yet is lightweight and easy to transport. The TOOL-TRA-TOP has a drill holster, convenient tray for tools/paint and small parts. There is also a sturdy molded paint can hanger on the backside of the top. The SPILL-PROOF pail shelf has a rag rack and holds a gallon paint can and automatically closes with the ladder

- WRN374CA – 4 feet**
- WRN376CA – 6 feet**
- WRN378CA – 8 feet**

Type I Fiberglass D-Rung Extension Ladder

250lbs Fiberglass ext ladders (D6000 series) The Fiberglass Step Ladder features a HolsterTop with the Lock-In System that allows you to customize your ladder top. The system secures tools from falling while keeping them handy while working increasing productivity on the job

- WRND6016-2CA - 16 feet**
- WRND6024-2CA - 24 feet**



WER05003473002

7 Piece Kraftform Kompakt Insulated Screwdriver Set (SI/PH/SQ)

WER05057111007

32 Piece Kraftform Kompakt Security Screwdriver Set, Wera (HXBO/SP/TXBO/SQ/TQST/TRW)

WER05021728002

950 PKL/13 SZ 13 Pc Ball End Hex L-Key Set, 0.05"-3/8"

WER05347778001

6 Piece Kraftform 300 Screwdriver Set (SI/Ph/Sq), 334/368/6

WER05073232002

8002 C KOLOSS 1/2 SB 1/2 Inch Drive Hammer-ratchet

WER05073661002

Kraftform Kompakt 27 RA Slotted Ratcheting Screwdriver, 1/4-Inch Head



Part	Description
825-10010	ATV All Terrain Vise
825-10015	ATV All Terrain Vise With Carrying Case
825-10300	ATV Mounting Bracket
825-10350	ATV Case Only

The Wilton B.A.S.H.® Unbreakable® Handle Sledge Hammer is the toughest sledge ever built. With molten steel bars reinforcing the handle, and a locking steel plate holding the head to that handle, the B.A.S.H.® will hold up when you need it most. Tested to 25,000 overstrikes, the B.A.S.H.® puts traditional wood and fiberglass hammers to shame!

BASH™ SLEDGE HAMMERS (46 HRC)

Part No.	Head Size	Handle Size
825-20212	2-1/2 lbs.	12"
825-20416	4 lbs.	16"
825-20624	6 lbs.	24"
825-20630	6 lbs.	30"



BASH™ SLEDGE HAMMERS (46 HRC)

Part No.	Head Size	Handle Size
825-20824	8 lbs.	24"
825-20830	8 lbs.	30"
825-20836	8 lbs.	36"
825-21030	10 lbs.	30"
825-21230	12 lbs.	30"
825-22030	20 lbs.	30"

Wilton® TRADESMAN VISES - SWIVEL BASE



Part	Description
825-63199	1745, Tradesman Vise , 4-1/2" Jaw Width, 4" Jaw Opening, 3-1/4" Throat Depth
825-63200	1755, Tradesman Vise, 5-1/2" Jaw Width, 5" Jaw Opening, 3-3/4" Throat Depth
825-63201	1765, Tradesman Vise, 6-1/2" Jaw Width, 6-1/2" Jaw Opening, 4" Throat Depth
825-63202	1780A, Tradesman Vise , 8" Jaw Width, 7" Jaw Opening, 4-3/4" Throat Depth

Wilton® UTILITY VISES - SWIVEL BASE



Part	Description
825-11126	674, Utility Vise , 4-1/2" Jaw Width, 4" Jaw Opening, 2-5/8" Throat Depth
825-11127	675, Utility Vise , 5-1/2" Jaw Width, 5" Jaw Opening, 3-3/16" Throat Depth
825-11128	676, Utility Vise , 6-1/2" Jaw Width, 5-1/2" Jaw Opening, 3-13/16" Throat Depth
825-191	656HD, Utility Vise, 6" Jaw Width, 6" Jaw Opening, 4-3/16" Throat Depth
825-11800	648HD, Workshop Vise, 8" Jaw Width, 7-1/2" Jaw Opening, 4-1/2" Throat Depth

CLASSIC 400 SERIES™ C-CLAMPS



Part	Description
825-14214	402, 400 Series C-Clamp, 0" - 2-1/8" Jaw Opening, 2-1/4" Throat Depth
825-14228	403, 400 Series C-Clamp, 0" - 3" Jaw Opening, 2-1/2" Throat Depth
825-14242	404, 400 Series C-Clamp, 0" - 4-1/4" Jaw Opening, 3-1/4" Throat Depth
825-14256	406, 400 Series C-Clamp 0" - 6-1/16" Jaw Opening, 4-1/8" Throat Depth
825-14270	408, 400 Series C-Clamp 0" - 8-1/4" Jaw Opening, 5" Throat Depth
825-14284	410, 400 Series C-Clamp, 2" - 10-1/8" Jaw Opening, 6" Throat Depth
825-14298	412, 400 Series C-Clamp, 2" - 12-1/4" Jaw Opening, 6-5/16" Throat Depth



3MS1100
Foam Ear Plug
Uncorded 200Units/Box

3MS1110 Foam
Ear Plug Corded
200Units/Box



Part	Description
3MS310-1001	E-A-R™, Classic™, Uncorded Earplugs, in Pillow Pack PVC
3MS311-1101	E-A-R™, Classic™, Corded Earplugs,
3MS311-1250	E-A-Rsoft™ Yellow Neons Corded Earplugs, In Poly Bag,
3MS312-1201	E-A-R™, Classic™, Uncorded Earplugs in Poly Bag
3MS312-1219	E-A-R™, TaperFit™, 2 Regular Uncorded Earplugs, in Poly Bag
3MS312-1250	E-A-Rsoft™ Yellow Neons Uncorded Earplugs , In Poly Bag,
3MS312-1252	E-A-Rsoft™ Yellow Neon Blasts Uncorded Earplugs , In Poly Bag
3MS340-4004	E-A-R™, UltraFit™, Corded Earplugs in Poly Bag



3MSH10A
Optime™, 105 Over-the-Head Earmuff Hearing Conservation Pivoting earcups for optimum fit. Twin cup design minimizes resonance, thus achieving maximum high and low frequency attenuation



3MSH10B
Optime™, 105 Behind-the-Head Earmuffs, Hearing Conservation H10B 10 EA/Case Pivoting earcups for optimum fit. Twin cup design minimizes resonance, thus achieving maximum high and low frequency attenuation



3MSH10P3E
Optime™, 105 Cap-Mount Earmuffs, Hearing Conservation 10 EA/Case Pivoting ear cups for optimum fit. Twin cup design minimizes resonance, thus achieving maximum high and low frequency attenuation



3MSH9A Optime™, 98 Over-the-Head Earmuffs, Hearing Conservation H9A 10 EA/Case H9A Model, high protection design. Pivoting ear cups for optimum fit. Soft seal liquid/foam filled cushions for a better seal even with eyewear. Works with AO Tuffmaster™ face protection system



3MSH7P3E
Optime™ 101 Cap-Mount Earmuffs H7P3E help provide effective hearing protection and are designed for noise levels up to 101 dBA. It features a universal mounting attachment that fits most hard hats and colour coding for compliance sighting.



3MSH7A
Optime™, 101 Over-the-Head Earmuffs, Hearing Conservation H7A 10 EA/Case H7A Model, high protection design. Padded steel headband with four point suspension for extra comfort. Pivoting earcups for optimum fit



3MSH7B
Deluxe backhand hearing protector, high protection design. Padded steel headband with four point suspension for extra comfort. Pivoting ear cups for optimum fit

3M™ Virtua Sport eyewear line combines outstanding style, protection and affordability. With numerous frame styles, lens tints and coatings, adjustability features and coverage profiles, the Virtua safety eyewear line can meet the needs for eye protection requirements



Part	Description
3MS11384-00000	3M™ Virtua™ Sport Protective Eyewear, Clear Anti-Fog Lens, Clear Temple
3MS11385-00000	3M™ Virtua™ Sport Protective Eyewear, Clear Hard Coat Lens, Clear Temple
3MS11386-00000	3M™ Virtua™ Sport Protective Eyewear, Grey Anti-Fog Lens

3M™ Virtua Cord Control System (CCS) Protective Eyewear with Foam Gasket Comfortable, lightweight frame features the Cord Control System (CCS) with optional foam gasket attachment. Meets the requirements of CSA Z94.3-07 and is Impact Rated to ANSI Z87.1-2010

Part	Description
3MS11872-00000	3M™ Virtua™ CCS Protective Eyewear, clear AF Lens, foam gasket
3MS11873-00000	3M™ Virtua™ CCS Protective Eyewear grey AF Lens, foam gasket,
3MS11874-00000	3M™ Virtua™ CCS Protective Eyewear, I/O Hard-coat Lens, foam gasket

3M™ Virtua Max™ Protective Eyewear. Lightweight, unisex Virtua protective eyewear combines versatility and value with high wraparound coverage, polycarbonate construction and a hard coat, scratch-resistant lens for a comfortable, contoured fit

Part	Description
3MS11510-00000	3M™ Virtua Max™ Protective Eyewear, Clear Anti-Fog Lens, Clear Frame
3MS11511-00000	3M™ Virtua Max™ gray anti-fog Lens
3MS11512-00000	3M™ Virtua Max™ indoor/outdoor gray anti-fog Lens





BX™ Safety Eyewear

BX safety eyewear adjusts to the workers, instead of workers having to adjust to it. With many adjustable features, BX eyewear provides a better fit, which can help your workers have a better attitude towards wearing their eyewear

Part	Description
3MS11374-00000	3M™ BX™ Reader Protective Eyewear, Clear Lens, Silver Frame, +1.5 Diopter
3MS11375-00000	3M™ BX™ Reader Protective Eyewear, Clear Lens, Silver Frame, +2.0 Diopter
3MS11380-00000	3M™ BX™ Reader Protective Eyewear, Clear Lens, Silver Frame, Anti-Fog
3MS11376-00000	3M™ BX™ Reader Protective Eyewear, Clear Lens, Silver Frame, +2.5 Diopter

3M™ Privo™ Protective Eyewear. Stylish Privo unisex protective eyewear looks as smooth as it functions. Bridges eurostyle and comfort with soft tips and temples, a gentle nose bridge, and a sturdy polycarbonate lens. Anti-fog coating allows for all-day, indoor or outdoor use

Part	Description
3MS12261-00000	3M™ Privo™ Protective Eyewear, Clear Anti-Fog Lens, Black Frame
3MS12262-00000	3M™ Privo™ Protective Eyewear, Grey Anti-Fog Lens, Black Frame/Orange
3MS12264-00000	3M™ Privo™ Protective Eyewear, I/O Mirror Lens, Black Frame
3MS12265-00000	3M™ Privo™ Protective Eyewear, Clear Lens, Silver/Red Frame

3M™ SecureFit™ Eye Protection features proprietary self-adjusting 3M™ Pressure Diffusion Temple Technology – a scientific advancement that helps diffuse pressure over the ear, enhancing frame comfort while at the same time ensuring a secure fit across diverse workforces

Part	Description
3MSSF201AF-CA-EA	Secure Fit Protective Eyewear SF201AF- Clear Anti-Fog Lens
3MSSF201AS-CA-EA	Secure Fit Protective Eyewear SF201AS-Clear Anti-Scratch Lens
3MSSF202AF-CA-EA	Secure Fit Protective Eyewear SF202AF-Gray Anti-Fog Lens
3MSSF203AF-CA-EA	Secure Fit Protective Eyewear SF203AF-Amber Anti-Fog Lens

3M™ SecureFit™, 400-Series, Protective Eyewear. The 400 Series features 3M™ Pressure Diffusion Temple Technology, soft adjustable nose pads & dual-injected temples

Part	Description
3MSSF401AF-CA	3M™ SecureFit™ Protective Eyewear, Clear Anti-Fog Lens
3MSSF402AF-CA	3M™ SecureFit™ Protective Eyewear, Anti-Fog Grey Lens
3MSSF410AS-CA	3M™ SecureFit™ Protective Eyewear, Indoor/Outdoor Mirror lens

3M™ Solus™ 1000 series protective eyewear features Scotchgard™ Anti-Fog lens coating which helps workers see clearly, longer – providing longer lasting fog resistance than traditional anti-fog coatings

Part	Description
3MSS1101SGAF	Solus 1000 Series, Blue/Black Eyewear with Clear Scotchgard™ Anti-Fog Lens
3MSS1101SGAF-KT	Solus 1000 Series, Blue/Black Eyewear with Clear Scotchgard™ Anti-Fog Lens and foam gasket and strap
3MSS1102GAF	Solus 1000 Series, Blue/Black Eyewear with Grey Scotchgard™ Anti-Fog Lensisor
3MSS1103SGAF	Solus 1000 Series, Blue/Black Eyewear with Amber Scotchgard™ Anti-Fog Lens

Part	Description
3MSV1A	V1A Black Matte Metal Visor
3MSV2A	V2A Clear Acetate Visor Not CSA
3MSV2C	V2C 140Ar Polycarbonate Visor Not CSA
3MSV4A	V4A Metal Visor

Part	Description
3MSH-700-RS4	Hard Hat H-700 Suspension Replacement - RS4, 4-Point
3MSH-701R	Hard Hat H-701R, 4-Point Ratchet Suspension, White
3MSH-701V	Hard Hat H-701V, Vented 4-Point Ratchet Suspension,
3MSH-702R	Hard Hat H-702R, 4-Point Ratchet Suspension, Yellow
3MSH-702V	Hard Hat H-702V, Vented 4-Point Ratchet Suspension, Yellow
3MSH-703R	Hard Hat H-703R, 4-Point Ratchet Suspension, Blue
3MSH-703V	Hard Hat H-703V, Vented 4-Point Ratchet Suspension, Blue
3MSH-704R	Hard Hat H-704R, 4-Point Ratchet Suspension, Green
3MSH-708R	Hard Hat H-708R, 4-Point Ratchet Suspension, Gray



3M Facepiece Respirators, Filters and Cartridges

Part #	Description
3MS6100	6000 Series Half Facepiece Respirators, Small
3MS6200	6000 Series Half Facepiece Respirators, Medium
3MS6300	6000 Series Half Facepiece Respirators, Large,
3MS6502QL	Rugged Comfort Quick Latch Half Facepiece Reusable Respirator Medium
3MS6700	Full Facepiece Reusable Respirator 6700, Respiratory Protection, Small
3MS6800	Full Facepiece Reusable Respirator 6800, Respiratory Protection, Medium
3MS6885	6000 Series Half and Full Facepiece Accessories, Peel Off Lens Cover Box of 25
3MS6900	Full Facepiece Reusable Respirator 6900, Respiratory Protection, Large
3MS7501	7500 Series Half Facepiece Respirators, Small
3MS7502	7500 Series Half Facepiece Respirators, Medium
3MS7503	7500 Series Half Facepiece Respirators, Large
3MSFF-401	Full Facepiece, Small
3MSFF-402	Full Facepiece, Medium
3MSFF-403	Full Facepiece, Large
3MS2078	2078 P95 OV / AG Filter
3MS7800S(L)	Full Facepiece 7800S-L, Large, Silicone
3MS7800S(M)	Full Facepiece 7800S M, Medium, Silicone
3MS2091	P100 Particulate Filter. Nuisance level organic Vapour/Acid gas relief
3MS2096	P100 Respiratory Protection, with Nuisance Level Acid Gas Relief
3MS2097	P100 High efficiency filter w/ozone protection Nuisance level organic Vapour/Acid gas relief
3MS5N11	N95 Particulate Filter
3MS5P71	5P71/07194 P95 Particulate Filter
3MS7093	P100 Particulate Filter
3MS7093-B	Particulate Filter P100 Bulk 144/Case
3MS6001	6000 Series Cartridge, Organic Vapor
3MS6002	6000 Series Cartridge, Acid Gas
3MS6003	6000 Series Cartridge, Organic Vapor/Acid Gas
3MS6006	6000 Series Cartridge, Multi Gas Vapour
3MS60921	600 Series Organic Vapour Cartridge
3MS60923	Organic Vapor/Acid GAS CTG/P100 Particulate filter
3MS60926	Multi Gas, P100 Filter
3MS501	6000 Series, Filter Retainer attachment to the 3M half and full facepiece
3MS502	6000 Series, HEPA Filter Adapter attachment to the 3M half and full facepieces

3M Disposable Respirators

Part #	Description
3MS8110S	Particulate Respirator 8110S, N95
3MS8200	Particulate Respirator 8200, N95
3MS8210	Particulate Respirator 8210, N95
3MS8210V	Particulate Respirator 8210V featuring 3M™ Cool Flow™ Valve
3MS8212	Particulate Welding Respirator 8212, N95, with Faceseal
3MS8214	Particulate Respirator 8214, N95, Faceseal/Nuisance Level Organic Vapour
3MS8233	Particulate Respirator 8233, N100, with Faceseal
3MS8247	Particulate Respirator 8247, R95, Nuisance Level Organic Vapour Relief
3MS8271	Particulate Respirator 8271, P95
3MS8293	Particulate Respirator 8293, P100, with Faceseal
3MS8511	Particulate Respirator 8511, N95
3MS8514	Particulate Respirator 8514, N95, Nuisance Level Organic Vapour Relief
3MS8515	Particulate Welding Respirator 8515, N95
3MS8576	Particulate Respirator 8576, P95, with Nuisance Level Acid Gas Relief
3MS8577	Particulate Respirator 8577, P95 w/ Nuisance Level Organic Vapour Relief
3MS9105	Particulate Respirator, N95 Flat-Fold V-Shaped
3MS9210+	Aura Particulate Respirator, N95
3MS9211+	Aura Particulate Respirator, N95



3MS450-01-01R20
3M™ Powerflow™ High Efficiency SP3 Particulate Filter. This filter helps provide high efficiency respiratory protection in environments containing particulates. Filter should be used with 3M™ Powerflow™ Powered Air Purifying Respirator (PAPR) systems



3MS504
Alcohol free respirator cleaning wipe- will not damage the facepiece materials. Individually wrapped to hold moisture and are stored in a convenient dispenser box



3MS82501-00000
H8A Ratchet Headgear - Easy window replacement. Five position crown strap for additional support and comfort. High strength thermoplastic



3MS82700-00000
W96 Clear Propionate Faceshield face protection to reduce the risk of splash, spray and light impact. Faceshield mounts inside headgear crown for added splash protection



3MS82701-00000
WP96 Clear Polycarbonate Faceshield. Good heat resistance. Windows mount inside crown for added impact strength. Heavy duty impact protection



3MSBE-10-3
3M Hood white- regular-tychem QC Double bib respirator hood is lightweight and comfortable. Helps provide respiratory protection for a wide range of applications



3MSFT-30
Qualitative Fit Test Apparatus. The Bitter Fit Test Solution is used with the Qualitative Fit Test Apparatus FT-30 to test the facepiece-to-face seal



3MSFT-32
Fit Test Solution Bitter. Can be used with any particulate respirator, or any gas/vapor respirator with particulate prefilter



3MSGVP-1
Belt-mounted powered air purifying respirator assembly includes components needed to make a complete, comfortable PAPR system



3MSGVP-440
High Efficiency Filter PAPR System Accessories, HEPA Filter, Magenta. Helps provide higher protection with greater comfort. Quick and easy replacement. Replacement part for 3M powered air purifying respirator (PAPR) systems



3MSGVP-441
Organic Vapor/HEPA Cartridges. Also operates as a high-efficiency particulate filter. NIOSH-approved cartridge used for respiratory protection against certain organic vapors



3MSS-607-10
3M™ Versaflo™ Replacement Hood with Inner Shroud for Premium Head Suspension, 10/Case



3MSTR-300-HIK
Versaflo™ Heavy Industry PAPR Kit is a complete, ready to use HE PAPR system for industrial applications



3MSTR-332
High Capacity Battery. Replacement battery for the 3M Versaflo powered respirator system



3MSTR-600-HIK
Versaflo™ Heavy Industry Powered Air Purifying Respirator Kit TR-600-HIK is for rugged operations such as industrial, demolition, grinding, metal finishing and casting. The 3M™ Heavy Industry Kit (TR-600- HIK) features 3M™ Hard Hat Assembly Headtop M-307, 3M™ Combination Cartridge TR-6530N (HE OV/AG), 3M™ Versaflo™ High Capacity Battery TR-632.



3MSTR-3712N-40
High Efficiency (HE) particulate filter for use with TR-300 Series PAPRs. The TR-3712N is a direct replacement for the TR-3710N. The TR-3712N filter is compatible with both filter covers TR-370 and TR-371.



3MSV-100
Vortex Cooling Ass V-100. Used to cool air supplied to 3M™ High Pressure Supplied Air Respirator Systems that use 3M™ L-Series Headgear by up to 50°F (28°C). The assembly allows user to adjust airflow and temperature for personal comfort



Fall Protection



Fall Protection

EXOFIT NEX™ VEST-STYLE HARNESS

Aluminum back D-ring, locking quick connect buckles.



Part	Description
098-1113001C	Exofit NEX Full Body Harness, 1D LQC (S)
098-1113004C	Exofit NEX Full Body Harness, 1D LQC (M)
098-1113007C	Exofit NEX Full Body Harness, 1D LQC (L)
098-1113010C	Exofit NEX Full Body Harness 1D, LQC (XL)
098-1113124C	ExoFit NEX™ Construction Style Positioning Harness 1D,LQC (M)



DELTA™ VEST-STYLE HARNESS

Back D-ring, tongue buckle leg straps.

Part	Description
098-1102000C	Delta Full Body Harness 1D, TB (U)
098-1101252C	Delta Full Body Harness 1D, TB (XL)
098-1102008C	Delta Full Body Harness 3D, TB (U)
098-1103321C	Delta Full Body Harness 3D PT (U)
098-1110600C	Delta Full Body Harness 1D QD (U)
098-1101654C	Delta Const. Full Body Harness 3D with belt (L)

PRO™ VEST-STYLE HARNESS



Part	Description
098-1191237C	PRO Full Body Harness 1D, TB (M/L)
098-1191238C	PRO Full Body Harness 1D, TB (XL)
098-1191201C	PRO Full Body Harness 1D, PT (M/L)
098-1191209C	PRO Full Body Harness 1D, TB, Hip Pad (M/L)



PRO™ VEST-STYLE HARNESS WITH COMFORT PADDING

Back D-ring, shoulder, back and leg padding, quick connect buckle legs.

Part	Description
098-1191253C	PRO Comfort Harness 1D, QD, (M/L)
098-1191254C	PRO Comfort Harness 1D, QD, (XL)

PRO WELDERS HARNESS

Protecta Welding Harness with Pass Thru Connections, Back D-ring. Resists char splatter up to 700° F and Lanyard Keeper

Part	Description
098-1191369C	PRO Welders Harness 1D, PT (S)
098-1191379C	PRO Welders Harness 1D, PT (M/L)
098-1191380C	PRO Welders Harness 1D, PT, (XL)
098-1191370C	PRO Welders Harness 3D, PT, (S)
098-1191381C	PRO Welders Harness 3D PT, (M/L)
098-1191382C	PRO Welders Harness 3D, PT, (XL)
098-1191371C	PRO Welders Harness 1D, TB, (S)
098-1191383C	PRO Welders Harness 1D, TB (M/L)
098-1191384C	PRO Welders Harness 1D, TB, (XL)
098-1191372C	PRO Welders Harness 3D, TB, (S)
098-1191385C	PRO Welders Harness 3D, TB, (M/L)
098-1191386C	PRO Welders Harness 3D, TB, (XL)
098-1191392C	PRO Welders Harness 3D,PT (M)



HARNESS ACCESSORIES



098-9501403C
Suspension Trauma Straps



098-1231117C
D-Ring Extension 18"



EZ-STOP™ LANYARD



Part	Description
098-1246011C	EZ Stop E4 S/A Lanyard 6' w/ Std. Hooks
098-1246017C	EZ Stop E4 S/A Lanyard 4' w/ Std. Hooks
098-1246012C	EZ Stop E4 S/A Lanyard 3' w/ Std. Hooks
098-1246195C	EZ Stop E4 Elastic Web S/A 100% Tie Off Lanyard 6' with Scaffold Hooks
098-1246105C	EZ Stop E6 S/A Lanyard 6' w/ Std. Hooks
098-1246095C	EZ Stop E6 S/A Lanyard 4' w/ Std. Hooks
098-1246115C	EZ Stop E6 100% Tie Off S/A Lanyard 6' w/ Rebar Hooks

SHOCKWAVE™2 LANYARD

Part	Description
098-1244306C	ShockWave E4 S/A Lanyard 6' with Standard Hooks
098-1244321C	ShockWave E4 S/A Lanyard 6' with Rebar Hook
098-1244409C	ShockWave E4 100% Tie Off S/A Lanyard 6' with Aluminum Rebar Hooks

PRO-STOP™ SHOCK ABSORBING LANYARD



Part	Description
098-1340220C	PRO Stop E4 S/A Lanyard 6' w/ Std. Hooks
098-1340221C	PRO Stop E4 S/A Lanyard 4' w/ Std. Hooks
098-1340230C	PRO Stop E4 S/A Lanyard 6' w/ Rebar Hook
098-1340250C	PRO Stop E4 100% Tie Off S/A Lanyard 6' w/ Rebar Hooks



Fall Protection



Fall Protection

PRO™ PACK SHOCK ABSORBING LANYARD

Part #	Description
098-1341001C	PRO E4 S/A Lanyard 6' w/ Std. Hooks
098-1341004C	PRO E4 S/A Lanyard 4' w/ Std. Hooks
098-1340125C	PRO E4 S/A Lanyard 6' w/ Rebar Hook
098-1340180C	PRO E4 100% Tie Off S/A Lanyard 6' w/ Rebar Hooks

Part	Description
098-1361001C	PRO E6 S/A Lanyard 6' w/ Std. Hooks
098-1361004C	PRO E6 S/A Lanyard 4' w/ Std. Hooks
098-1360125C	PRO E6 S/A Lanyard 6' w/ Rebar Hook
098-1360180C	PRO E6 100% Tie Off Lanyard 6' with Rebar Hooks

REBEL™ LEADING EDGE

Part #	Description
098-3590518	Rebel 20' Steel Cable with Swivel Snap Hook
098-3590502	Rebel 33' Steel Cable with Swivel Snap Hook
098-3590552	Rebel 50' Steel Cable with Swivel Snap Hook
098-3590541	Rebel 20' Leading Edge with Swivel Snap Hook
098-3590544	Rebel 10m Leading Edge

NANO-LOK™ EDGE SELF RETRACTING LIFELINE

Part#	Description
098-3500217	Nano-Lok Edge Sgl. Leg 8' w/ Steel Snap Hook
098-3500234	Nano-Lok Edge Dbl. Leg 8' w/ Steel Locking Nose rebar Hooks

REBEL™ PROTECTA SELF RETRACTING LIFELINE

Part #	Description
098-3100429	Rebel 10' Web w/ Swivel Snap Hook
098-3100435	Rebel 20' Web w/ Swivel Snap Hook
098-3590017	Rebel 10' Steel Cable w/ Swivel Snap Hook
098-3590513	Rebel 33' Steel Cable w/ Swivel Snap Hook

098-1244448C

ShockWave™2 100% Tie-Off Shock Absorbing Lanyard. 6 ft. (1.8m) double-leg 100% tie-off with elastic web and snap hook at center, Saflok-Max™ steel rebar hooks at leg ends.

The 3M™ DBI-SALA® Comfort Grip Connector was designed for workers who need the flexibility to anchor efficiently and comfortably in multiple orientations. Whether you are using a snaphook 10 times or 1000 times per day, the 3M™ DBI-SALA® Comfort Grip Connector will help make your job easier. Snap into work mode



Part	Description
098-3101668	NanoLok 6' Twin QC Comfort Grip ends,CSA
098-3101669	NanoLok 6' Twin,Fix D,Comfort Grips,CSA
098-3101670	NanoLok 6' Twin, HW, Comfort Grips,CSA
098-3101671	NanoLok 6',3100064,Comfort Grip end,CSA
098-3101672	NanoLok XL 9' Twin, Comfort Grips,CSA
098-3101676	NanoLok 6',Comfort Grip end,CSA
098-3101677	NanoLok 6' 3100064,HW, Comfort Grip,CSA
098-3101678	NanoLok XL 9' 3100064, Comfort Grip,CSA
098-3500259	Nano Edge 8' Twin,Comfort Grip ends,CSA
098-3500260	Nano Edge 8',Comfort Grip end,CSA

098-2199910 3M CSA Roofer's Kit - Kit Includes:

1. Rope grab with integral 2' shock absorbing lanyard, First 5-point harness (pass through or tongue buckle options), 50' vertical lifeline, & reusable roof anchor, in a plastic pail.

Rope grab with attached 2' shock absorber

Harness

Lifeline

Reusable Roof Anchor



098-2100159
Fixed Beam Anchor



098-2100085C
Concrete Wedge Anchor



098-2100090

Perimeter Limiter Leading Edge Anchor

The Perimeter Limiter's design makes the anchor provides an overhead anchor for up to two users that minimizes fall distances while reducing swing falls. Once craned into position on the deck, the Perimeter Limiter is pushed to a location and is ready to use. When it comes time to relocate the anchor to another area, it can be maneuvered in two ways. The Perimeter Limiter's mast and anchorage arm can rotate around the counterweights making relocation to another close by area fast. If the anchor has to move across the deck to an area further away, the foam filled trailer tires and up front push bars make this easy.

SAFETY

Ansell



HYFLEX® 11-500

White polyurethane palm coated, white nylon liner, Light Duty
012-11-500-8
012-11-500-9
012-11-500-10



HYFLEX® 11-501

Superior cut protection and dexterity in a versatile glove
012-11-501-8
012-11-501-9
012-11-501-10



HYFLEX® 11-624

Dyneema®, Spandex® and nylon liner, polyurethane palm coating, gray and black
012-11-624-8
012-11-624-9
012-11-624-10



HYFLEX® 11-800

Gray foam nitrile palm coated, white nylon liner Light Duty
012-11-800-8
012-11-800-9
012-11-800-10



HYFLEX® 11-801

Black foam nitrile palm coated, gray nylon liner, Light Duty
012-11-801-8
012-11-801-9
012-11-801-10



HYCRON® Nitrile Coated, Heavy Duty, Fully coated, 2.5" safety cuff
012-27-805-XL



POWER FLEX® T° HI VIZ YELLOW™
Cold Environment, Latex Coated, Acrylic Thermal Liner, Crinkle Finish Palm coated, fluorescent yellow
012-80-400-9
012-80-400-10



HYD-TUF®

Nitrile Coated, Cloth Back, Medium to Heavy Duty-Safety cuff
012-52-547-L
012-52-547-XL



TOUCH N TUFF® - NITRILE

Powder-free, 5 mils, rolled cuff, teal, 100 gloves/dispenser box
012-92-600-M
012-92-600-L
012-92-600-XL



SOL-VEX®

Nitrile, Unsupported 11 mils, 13", green embossed
012-37-145-8
012-37-145-9
012-37-145-10



SOL-VEX®

Nitrile, Unsupported Flock lined, 15 mils, 13", green embossed
012-37-175-8
012-37-175-9
012-37-175-10



HYLITE®

A versatile alternative to cotton, light leather and PVC gloves. For extra comfort, Hylite gloves feature interlock knit lining, generous sizing, and contoured designs
012-47-402-9
012-47-402-10



Hyd-Tuf™

Nitrile impregnated coating on a jersey liner
012-52-547-L
012-52-547-XL



POWERFLEX® Exclusive 13 gauge composite yarn liner, with unique soft black palm coating. Flame resistance is inherent in glove materials
012-80-813-9
012-80-813-10

SAFETY



COMTV591RS
Tear away traffic vest
Traffic vest with 2" yellow high visibility reflective material on a bright orange polyester mesh



COMTV591RS-SLV
Tear away traffic vest
Traffic vest with 2" 3M silver reflective material on a bright orange polyester mesh

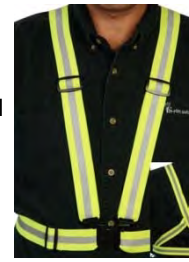

COMSB20E
Traffic sash belt
Elasticized sash belt with 1 1/2" yellow/silver reflective material



COMAS14E
Ankle elastic band yellow/silver/yellow 14" reflective material



BARRICADE TAPE 0.045mm THICK 3" X1000 FT PER ROLL
COMCT3RE8 - Red barricade tape "Danger Do Not Enter"
COMCT3RE9 - Red barricade tape "Danger"
COMCT3YE1 - Yellow barricade tape "Caution"
COMCT3YE2 - Yellow barricade tape "Caution Do Not Enter"



135-BK110AF
Bear Kat Clear Anti-Fog Lens



135-BK110
Bear Kat Clear Lens



135-BK112
Bear Kat Gray Lens



135-BK114
Bear Kat Amber Lens



135-BK119
Bear Kat Indoor/Outdoor Mirror Lens



135-CL110
Checklist Clear Frame, Clear Lens



135-DL118B
Dallas Black Frame, Blue Mirror Lens



135-KD110
Klondike Black Frame, Clear Lens



135-KD110AF
Klondike Black Frame, Clear Lens Anti-Fog



135-KD112
Klondike Black Frame, Gray Lens



135-LW210
Law@ 2 - Orange Temple Inserts, Clear Lens



135-SS110
Storm Black Frame, Clear Lens



135-ST1130
Storm Black Frame, 3.0 Green Lens



135-ST1150
Storm Black Frame 5.0 Green Lens



135-TK110
Tomahawk Black Frame 3.0 Clear Lens



DEG12340
SPF 30 Lotion
120mL - 4oz Bottle



DEG12350
SPF 30 Lotion
1000ML - 34 oz Bottle



DEG12380
SPF 50 Lotion,
125mL - 4.4oz tube



DEG12402
10% DEET
Towelettes, 5.85 grams Individual use



DEG12425
10% DEET
Liquid Spray,
120 mL - 4 oz bottle



DEG12435
28.5 % DEET,
OTHER actives
1.50% Aerosol,
150g - 5.29oz can.



DEG12545
Wasp & Hornet
Killer, 325gram
14oz Can.



ReFlex-Wear CSA Class 2 Level 2 T-shirts

- Orange or Lime Green
- 100% Polyester birdeye fabric
- Large front pocket
- X-Back striping
- Machine washable

Part#	Description	Size
DEG7815470	Lime Green 2inch Reflex-Wear Tape	M-4XL
DEG7815475	Orange 2inch Reflex-Wear Tape	M-4XL
DEG7815490	Green Long Sleeve Shirt Lime 2inch Tape	M-4XL



DEG7845300-LG/XL DEG7845300-2XL/3XL
 CSA Traffic Vest, Hi-Viz orange solid vest with velcro closure. Tear - away shoulders, sides and front, with D-ring access. 2" inch grey and yellow vertical front, X back stripes, with 4 pockets 360° horizontal Stripes around the waist 3M Reflective Scotchlite Material



DEG7845375-LG/XL
 CSA Traffic Vest, Lime green solid vest with velcro closure. Tear - away shoulders, sides and front, with D-ring access. 2" inch grey and yellow vertical front, X back stripes, with 4 pockets 360° horizontal Stripes around the waist 3M Reflective Scotchlite Material



DEG7091000 CLR Clear Lens
 Black Nylon Frame
 JS200 Light-weight Impact resistant Nylon Frame, with Single Lens style, designed to fit men and women, integrated nose piece, bayonet style temples, impact resistant polycarbonate lenses provides 99.9% UV protection, scratch resistant coating, ANSI Z87.1/CSA Z94.3-07



DEG7098501 GRY
 Jazz JS 501- Ultra-lightweight construction, single lens style wrap-around design, molded-in brow guard and side shields provide superior peripheral vision and side protection. Silicone clear nosepiece and soft rubber non-slip temple tip pads for added comfort. polycarbonate lens provides 99.9% UV protection, scratch resistant coating. ANSI Z87.1/CSA Z94.3-07



DEG7102000 CLR
 Soft PVC frame, green shaded, fits over most prescription eyewear, designed to fit men and women. Impact resistant polycarbonate lens provides 99.9% UV protection, scratch resistant coating, CSA/ANSI Z87.1



Jazz JS 401- Ultra-lightweight wraparound design for men and women, combines a sleek appearance with rugged durability, features rubberized temples, frameless polycarbonate lens construction, provides 99.9% UV protection, scratch resistant coating, ANSI Z87.1/CSA Z94.3-07



DEG7098200 AF CLR
 Light-weight construction combines a sleek appearance with comfort and durability. Frame-less high impact polycarbonate single lens style, silicone clear nosepiece and soft non-slip rubber temple tip pads ensure a comfortable and secure fit. Anti-fog lens provides 99.9% UV protection, scratch resistant coating ANSI Z87.1/CSA Z94.3-07



DEG7102000 AFC
 JG 1000 Goggle - chemical Splash Indirect ventilation, clear anti-fog lens



DEG7130000 AFC
 A soft PVC frame with a wraparound design with foam liner inside the lens frame. Adjustable Nylon headband for an excellent fit. Features a polycarbonate lens with UV Protection. Impact Resistant Lens. CSA/ANSI Z87.1

- DEG7093401 CLR** Clear Lens
- DEG7093401 GRY** Grey Lens
- DEG7093401 IOM** Indoor/Outdoor Mirror Lens

DEG77200A-32
 DEPLUG Tapered Fit Polyurethane NRR 32 Uncorded



DEG7240000
 Headgear with adjustable ratchet suspension and sweatband for added comfort. Use with Mach & Mach I replacement visors. Yellow



DEG7285000 RSS
 Mach Supreme Full With Polycarbonate Visor
DEG72R8500 PCC
 Mach Supreme Replacement Visor Polycarbonate



DEG81AR WHT Wave Ratchet Sizing Adjustment And 4 Point Nylon Provides crown impact & penetration force transmission protection and dielectric protection up to 20 20kV. Other colours also available



DEG81CR NBL
 The Wave CSA Type 2 Hard Hat Ratchet Navy Blue. Other colours also available



DEG81CR WHT
 The Wave CSA Type 2 Hard Hat Ratchet White. Other colours also available



DuPont™ ProShield® NexGen® Constructed with a soft fabric and excellent breathability, ProShield® coveralls from DuPont help protect against non-hazardous particles and light liquid splash



Part#	Description
251-NG120SWHSM002500	Proshield® Nexgen® Coverall White Small - 25/Case
251-NG120SWHMD002500	Proshield® Nexgen® Coverall White Medium - 25/Case
251-NG120SWHXL002500	Proshield® Nexgen® Coverall White XL - 25/Case
251-NG120SWH2X002500	Proshield® Nexgen® Coverall White 2X- 25/Case
251-NG120SWH3X002500	Proshield® Nexgen® Coverall White 3X – 25/Case
251-NG120SWH4X002500	Proshield® Nexgen® Coverall White 4X - 25/Case
251-NG120SWH5X002500	Proshield® Nexgen® Coverall White 5X- 25/Case



Part#	Description
251-NG127SWHSM0025NP	Proshield® Nexgen® Coverall White Small – 25/Case
251-NG127SWHMD0025NP	Proshield® Nexgen® Coverall White Medium– 25/Case
251-NG127SWHXL0025NP	Proshield® Nexgen® Coverall White XL – 25/Case
251-NG127SWH2X0025NP	Proshield® Nexgen® Coverall White 2X– 25/Case
251-NG127SWH3X0025NP	Proshield® Nexgen® Coverall White 3X– 25/Case

Tempro® coveralls are designed to help protect and preserve primary flame-resistant garments. Lightweight, limited-use over-garments, Tempro® coveralls provide a barrier against non-hazardous particles and aerosols



Part#	Description
251-TM127SBULG002500	Tempro® Coverall Blue Large – 25/Case
251-TM127SBUXL002500	Tempro® Coverall Blue X-Large – 25/Case
251-TM127SBU2X002500	Tempro® Coverall Blue - 2X – 25/Case
251-TM127SBU3X002500	Tempro® Coverall Blue - 3X – 25/Case
251-TM127SBU4X002500	Tempro® Coverall Blue - 4X – 25/Case
251-TM127SBU5X002500	Tempro® Coverall Blue 5X – 25/Case



251-TY500SWH00020000
Dupont™ Tyvek® Sleeve
White Universal – 25/case



251-TY450SWH00020000
Dupont™ Tyvek® Shoe
Cover White Universal
200/case

Dupont Tyvek Lab Coat White serged seams – collar - front snap closure - two pockets



Part#	Description
251-TY212SWHLG003000	Dupont™ Tyvek® Lab Coat White Large - 30/Case
251-TY212SWHXL003000	Dupont™ Tyvek® Lab Coat White XL - 30/Case
251-TY212SWH2X003000	Dupont™ Tyvek® Lab Coat White 2X - 30/Case
251-TY212SWH3X003000	Dupont™ Tyvek® Lab Coat White 3X - 30/Case
251-TY212SWH4X003000	Dupont™ Tyvek® Lab Coat White 4X - 30/Case
251-TY212SWH5X003000	Dupont™ Tyvek® Lab Coat White 5X - 30/Case



251-TY273BWH00010000
Dupont™ Tyvek® Apron
White Universal 100/Case



251-TY454SWH00010000
18" Dupont™ Tyvek® Boot
Cover White Universal
100/Case



251-TY450SWH00010000
8" Dupont™ Tyvek® Ankle
Boot Cover White Universal
200/Case

DuPont™ Tyvek® Coveralls

- Provide light-weight inherent barrier protection against hazardous dry particles and aerosols, and nonhazardous light liquid splash
- Are good for industrial workers in a variety of applications including general maintenance/operations, asbestos and lead abatement, mold remediation, and environmental cleanups
- Provide excellent abrasion resistance
- Helps protect workers against small size hazardous particles

Style 120 - serged seams - collar - front zipper closure - elastic waist



Part#	Description
251-TY120SWHMD002500	Dupont™ Tyvek® Coverall White Medium – 25/Case
251-TY120SWHLG002500	Dupont™ Tyvek® Coverall White Large – 25/Case
251-TY120SWHXL002500	Dupont™ Tyvek® Coverall White X-Large – 25/Case
251-TY120SWH2X002500	Dupont™ Tyvek® Coverall White 2X – 25/Case
251-TY120SWH3X002500	Dupont™ Tyvek® Coverall White 3X – 25/Case
251-TY120SWH4X002500	Dupont™ Tyvek® Coverall White 4X – 25/Case

Style 122 - serged seams - attached hood (respirator fit) - front zipper closure elastic wrists - elastic ankles - elastic waist - attached skid-resistant boots



Part#	Description
251-TY122SWHLG002500	Dupont™ Tyvek® Coverall White Large -25/Case
251-TY122SWHXL002500	Dupont™ Tyvek® Coverall White XL – 25/Case
251-TY122SWH2X002500	Dupont™ Tyvek® Coverall White 2X – 25/Case
251-TY122SWH3X002500	Dupont™ Tyvek® Coverall White 3X – 25/Case
251-TY122SWH4X002500	Dupont™ Tyvek® Coverall White 4X – 25/Case

Style 125 – serged seams - collar - front zipper closure - elastic wrists elastic ankles - elastic waist - comfort fit design



Part#	Description
251-TY125SWHLG002500	Dupont™ Tyvek® Coverall White Large - 25/Case
251-TY125SWHXL002500	Dupont™ Tyvek® Coverall White XL - 25/Case
251-TY125SWH2X002500	Dupont™ Tyvek® Coverall White 2X - 25/Case
251-TY125SWH3X002500	Dupont™ Tyvek® Coverall White 3X - 25/Case
251-TY125SWH4X002500	Dupont™ Tyvek® Coverall White 4X - 25/Case

Style 127 - serged seams - attached hood (respirator fit) - front zipper closure elastic wrists - elastic ankles - elastic waist



Part#	Description
251-TY127SWHMD002500	Dupont™ Tyvek® Coverall White Medium - 25/Case
251-TY127SWHLG002500	Dupont™ Tyvek® Coverall White Large - 25/Case
251-TY127SWHXL002500	Dupont™ Tyvek® Coverall White - XL 25/Case
251-TY127SWH2X002500	Dupont™ Tyvek® Coverall White 2X - 25/Case
251-TY127SWH3X002500	Dupont™ Tyvek® Coverall White 3X - 25/Case
251-TY127SWH4X002500	Dupont™ Tyvek® Coverall White 4X - 25/Case
251-TY127SWH5X002500	Dupont™ Tyvek® Coverall White 5X - 25/Case

DuPont™ Tyvek® 500 HV coveralls combine proven chemical, biological and antistatic protection with the highest class of high visibility. Designed for limited use only, Tyvek® 500HV garments provide outstanding safety performance without the hassle of repeated washing and monitoring. Every time. All the time



Part#	Description
251-TY125SHVMD002500	Dupont™ Tyvek® 500 HV Coverall White Medium - 25/Case
251-TY125SHVLG002500	Dupont™ Tyvek® 500 HV Coverall White Large - 25/Case
251-TY127SHVXL002500	Dupont™ Tyvek® 500 HV Coverall White - XL 25/Case
251-TY127SHV2X002500	Dupont™ Tyvek® 500 HV Coverall White 2X - 25/Case
251-TY127SHV3X002500	Dupont™ Tyvek® 500 HV Coverall White 3X - 25/Case
251-TY127SHV4X002500	Dupont™ Tyvek® 500 HV Coverall White 4X - 25/Case

The Techno EP850 Series

- Wraparound lightweight, frameless spectacles
- One piece lens with soft rubber temple ends
- Soft silicone nose piece for non-slip
- The lenses are protected with 4A Coating:
- Anti-Fog, Anti-Scratch, Anti-UV 99.9%
- and Anti-Static
- CSA Z94.3-7 certified and meets and/or exceeds ANSI Z87.1 requirements



DSIEP855C
Mini Techno Safety
Glasses Amber Clear



DSIEP855S
Mini Techno Safety
Glasses Smoke



DSIEP850C
Techno Safety
Glasses Clear



DSIEP850S
Techno Safety Glasses
Smoke Lens

The Solus EP550 Series

- Wide field uni-lens design offering unobstructed vision
- Made of very lightweight high impact resistant Polycarbonate



DSIEP550C
Solus Safety
Glasses Clear Lens



DSIEP550S
Solus Safety
Glasses Smoke
Lens

DSIEP500C

- Curve Safety
Glasses Clear Lens
- Popular low profile shape
 - High 9 base curve for better coverage and wide field of view
 - Absorbs more than 99.9% of harmful UV light
 - CSA Z94.3-7 certified and meets and/or exceeds ANSI Z87.1 requirement

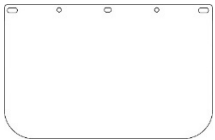

All the visors, faceshields and windows offer the multi-fit attachment pattern (or universal fit). This pattern consists of 5 slots strategically located to fit a wide variety of headgear and brackets

Part	Description
DSIEP1015/40	Diecut Window 10 X 15 ½ PETG Poly .40 - Clear
DSIEP1015/60	Diecut Window 10 X 15 ½ PETG Poly .60 - Clear
DSIEP815/40	Diecut Window 8 X 15 ½ PETG Poly .40 - Clear
DSIEP815/60	Diecut Window 8 X 15 ½ PETG Poly .60 - Clear



DSIEPB101
Plastic bracket, totally dielectric and blades for slotted hard hats



DSIEPB201
Aluminum bracket, heat resistant, with Cam lock system



DSIEPHG300R
3" crown face shield, Headgear with ratchet suspension head band- light weight- made out of HDPE



DSIHP241R/01
Whistler - Hard hat with rain trough, HDPE shell, 4-point nylon suspension, "Sure-Lock" Ratchet adjustment, 4 anchor points for chin strap



DSIRP513N95
Disposable particulate respirator, N95, closed cell foam nose cushion



DSIRP713N95
Disposable particulate respirator, N95, closed cell foam nose cushion



DSIRP714N95
Disposable particulate respirator, N95, with exhalation valve and closed cell foam nose cushion



DSIFP1001D
 "DYNA-PRO" Universal Harness - Integrated breathable comfort pad at the back, shoulders and leg straps. Bayonet style connectors. 1 large back D-ring. CSA certified class A



DSIFP1001DG
 "DYNA-PRO" Universal Harness - Integrated breathable comfort pad at the back, shoulders and leg straps, 1 large back D-ring and grommeted leg straps. CSA certified class A



DSIFP2501D
 Harness Vest Style Hybrid Econo with adjustable shoulder straps, 1 large back stamped D-ring, pass-thru quick connect D-ring, grommeted leg straps. CSA certified class A.



DSIFP2501DG
 Harness Vest Style Hybrid Econo with adjustable shoulders straps, 1 large back stamped D-ring, grommeted leg straps. CSA certified class A



DSIFP105311/6
 Lanyard Dyna-Fusion 2-IN-1 Lanyard 6 ft long (1,8 m) fixed with 2 double locking ergonomic snap hook model



DSIFP105313/6 Lanyard Dyna-Fusion 2-IN-1 Lanyard 6 ft long (1,8 m) fixed with 1 double locking ergonomic snap hook model FP6650HS at one end and 1 double locking Rebar hook FP5386HS at the other



DSIFP16/3.5
 Disposable anchor sling with protective sleeve 3-1/2 ft long (8,8 cm).



DSIFP13/3
 Residential anchor sling made of polyester webbing, 3 ft (0,9 m) long



ERG12210
 Chill-Its® 6215 Phase Change Premium Cooling Vest with packs. Maintains constant 64°F / 18°C Cooling lifecycle lasts up to 4 hours. Comfortable cotton construction with hook and loop closure L/XL



ERG12305
 Chill-Its® 6700 Evaporative Cooling Bandana - Tie Red Western



ERG12307
 Chill-Its® 6700 Evaporative Cooling Bandana - Tie - Solid Blue



ERG12337
 Chill-Its® 6715 Evaporative Cooling Hard Hat Pad. Attaches to standard hard hat headband.

ERG12338
 Chill-Its® 6716 Evaporative Cooling Hard Hat Liner. Attaches to standard hard hat headband.



ERG12479
 Chill-Its® 6615 High-Performance Dew Rag Redwestern Technical fabric transports moisture away



ERG12523
 Chill-Its® 6670CT Evap. Hard Hat Neck Shade w/CT. Advanced PVA material activates easily and quickly when run under water for one minute. Re-usable, just re-wet. hydrated for up to 4 hours



ERG12420-Blue ERG12438-Gray ERG12439-Lime ERG12441-Orange
 Chill-Its® 6602 Evaporative Cooling Towel Advanced PVA cooling technology Super-evaporative, feels significantly cooler than ambient air Activates fast and easy. Run under cold water for one minute Wear for hours or for quick relief Simply re-wet to reactivate Machine washable Size: 13" x 29.5" (33cm x 75cm)



ERG29061
 GloWear® 8006 Hi-Vis Neck ANSI-compliant polyester solid fabric (3.6oz) Reflective binding. Hook and loop closures attaches to hard hat suspension headbands



ERG16810
N-Ferno® 6810
Stretch Cap -
Half Style
 100% polyester knit



6310 TREX™ Adjustable Ice Traction Device

Adjustable one-piece traction device for shoes or boots delivers tenacious grip and stability.
ERG16773 Medium(5-8)
ERG16774 Large (8-11)
ERG16775 X-Large (11-14)



6300
Trex Foot Wear

One piece traction device for shoes or boots delivers grip and stability
ERG16753 Medium(5-8)
ERG16754 Large (8-11)
ERG16755 X-Large (11-14)



ERG16821
N-Ferno™ 6821

Cool Series Balaclava Long length. FR treated for safety single wash. Polyester fleece • One size, Black



ERG16885
N-Ferno® 6885 Two-layer FR Winter Liner

Versatile design with detachable upper and lower sections to provide the ultimate in winter and FR protection. Meets performance requirements of ASTM F1506.



ERG16950
N Ferno™ 6950 Extreme Series Winter Liner

Long length • Shell: 100% quilted nylon • Mid-Layer: Foam • Lining: 100% poly Sherpa • FR treated for safety (single wash) One size, Black w/white



ERG16990
 Warming Packs. Self contained packs add heat anywhere when exposed to air. Hand Style warms up to 8 hours



ERG19002
 Squids® 3100 Single Carabiner-10lb Tool Lanyard-Tethers tools to help worker prevent injury, damage and lost productivity from dropped tools.



ERG19023
 Squids® 3110 Dual Carabiner - 10lbs Tool Lanyard - Dual Carabiners: Tethers tools to help worker prevent injury, damage and lost productivity from dropped tools.



ERG19155
 Squids® 3155 Elastic Hard Hat Lanyard with Clamp. Easily and comfortably secures a hard hat to a worker to prevent the item from falling.



ERG13305
 Arsenal® 5005P Large Fire & Rescue Gear Bag - Polyester



ERG18380
 ProFlex® 380 Standard Kneeling Pad. Comfort for static kneeling situations. Closed-cell foam is non-conductive, resistant to petroleum, and silicone-free. Convenient handle.

fend·all®

FEN32-000200-0000
 Porta Stream II Emergency Eyewash Station, with 180 oz. Saline Offers versatile portability and 15-minutes of uninterrupted flushing without costly plumbing



FEN32-000400-0000
 Flash Flood Emergency Eyewash Station, 1 gallon Cartridge replacement is quick and easy. Dual nozzles flush both eyes simultaneously. Flash Flood™ delivers Eyesaline™ Solution. Wall mounted



FEN32-000401-0000
 Flash Flood Cartridge Refills Only- Trilingual (3 Minute) 1 gal, 4 per Pail

FEN32-000455-0000
 Sterile Eyewash Bottles 32 oz. Trilingual 12/Case Portable and readily available for use, these emergency eyewash bottles contain a buffered, saline solution that is sterile and superior to tap water for emergency



FEN32-000513-0000
 Saline Concentrate 180 oz. Use with Fendall Porta Stream I, II or other 14-16 Gallon Stations Buffered saline eyewash. For use with Fendall Porta Stream™ Eyewash



FEN32-001000-0000
 Pure Flow 1000 emergency eyewash station delivers the required 15 minutes of flushing with a preserved, buffered, saline solution that is superior to tap water for emergency eye care



HAW7261-7271
AXION® MSR Pedestal Eye/Face Wash Model 7261-7271, pedestal mounted, plastic bowl eye/face wash with AXION® MSR eye/face wash head.



HAW7360BTWC
AXION® MSR Wall Mount Eye/Face Wash Model 7360BTWC, barrier-free, wall mounted eye/face wash with AXION® MSR eye/face wash head, with tailpiece and trap.



HAW7501T
Portable Gravity Fed Heated Eyewash. Model 7501T, 9-gallon (34 L), gravity-fed, tempered portable eyewash that uses a heated, insulated blanket

HAW7610
AXION® MSR Sink Mount Eye/Face Wash. Model 7610, barrier-free, single action swing-down eye/face wash with AXION® MSR eye/face wash head designed to be mounted on either rear of sink or counter top.



HAW7611
AXION® MSR Sink Mount Eye/Face Wash. Model 7611, single action swing-away eye/face wash with AXION® MSR eye/face wash head designed to be mounted on left or right side of sink.



HAW7612
AXION® MSR Sink Mount Eye/Face Wash. Model 7612, swing-away eyewash designed to be mounted on right side of sink, with AXION® MSR stainless steel eye/face wash head.



HAW8122
AXION® MSR Wall Mount Drench Shower Model 8122, horizontal or vertical drench shower with AXION® MSR ABS plastic showerhead.

HAW8309WC
AXION® Accessible Eye/Face Wash and Shower. Model 8309WC, barrier-free, combination shower and eye/face wash with AXION® MSR eye/face wash and shower head.

HAW8330
AXION® Stainless Eye/Face Wash and Shower. Model 8330, corrosion-resistant, all stainless steel combination shower with AXION® MSR eye/face wash and shower head.



HAW9201H
AXION® Emergency Tempering Valve. Model 9201H Lead-free AXION® Emergency Tempering Valve thermostatically mixes hot and cold water to provide a safe fluid supply for emergency showers and eyewash equipment, with a flow rate of 31 gpm (117.3 L).

HAWSP829SS
Emergency Drench Shower Head Model SP829SS, AXION® MSR stainless steel drench showerhead with integral 20 gpm (75.7 L) flow control.



HAWAX14
AXION® Advantage® Upgrade System Model AX14, AXION Advantage™ eye/face wash and shower upgrade system. This system is designed to replace outdated, under-performing or in some cases, non-conforming installed emergency eyewash/shower combinations with the medically superior AXION® MSR performance. This revolutionary inverted flow design is the only product on the market that provides a Medically Superior Response consistent with all EMT, emergency room and doctors' office protocols by sweeping contaminants away from the vulnerable nasal cavity. System includes the AXION MSR eye/face wash head and shower head, the necessary connecting hardware, along with a tape measure, eyewash measuring gauge and written guidelines to assure installation complies with the ANSI Z358.1 standard





BIL1010924
Lightning Earmuff
NRR30dB Noise
Reduction Rate.



BIL1010928
Thunder T1 Headband
Earmuff- Dielectric.
Construction with a
plastic headband that
does not conduct
electricity.



BIL1010970
Thunder T3 Headband
Earmuff – Dielectric NRR
30 Dielectric construction
suitable for all workplaces,
especially electrical
environments.



HOWFF-1
FirmFit Uncorded
Earplugs, Orange,
Polybag. Distinct
warning orange color
makes compliance
checks easy. Easy to
insert.



HOWLL-1
LASER LITE Bright,
low-pressure single
use foam earplug.
Contoured T-shape
for easy insertion
and wear 200/box



HOWLL-30
Laser-Lite
Foam Plug
Polycord
100/Box



HOWLL-1-D
Uncorded Laser Lite
Disposable
Earplugs Uncorded.
NRR 32
Dispenser Refills
500 pair/Box
4 Box/Case



HOWLPF-1
Max Lite Disposable
Earplugs, Uncorded,
Individual Polybag,
Contoured T-shape
for easy insertion
and wear
200 pair/Box



HOWLT-30
Laser Trak safety
earplugs offer high
visual and metal
detectability in a
Single-Use earplug
100 /Box



HOWMAX-1
Max Highest Attenuating
Single-Use Earplug
Uncorded NRR 33
Bell shape delivers
maximum in-ear comfort
200 pair/Box



HOWMAX-30
Max Highest
Attenuating
Single-Use
Earplug corded
100 /Box



HOWQB2HYG Quiet Bands
10/Box (10Bx/Cs) NRR 25
Re-sealable Bag Designed for
people who are exposed to
intermittent noise, QB2HYG
offers solid protection with its
supra-aural fit.
10/Box



HOWQB3HYG
Quiet Bands. Banded Earplugs
Quiet Designed for people who
are exposed to intermittent
noise, QB3HYG offers good
protection with its semi-aural
10/ Box



HOWQD30
Quiet Reusable Earplugs
Corded Built-in insertion
stem makes insertion
quick and easy.
Contoured shape
comfortably matches
contours of the ear
100/Box



HOWQM24+
Multiple-Position
Headband Earmuff
Dielectric



HOWSDT-30
Smartfit Detectable
Triple-flange multiple-use
detectable earplug
100/Box



HOWSMF-30
Smart Fit Corded NRR
25. Optional Cord, HearPack
Conforming Material
Technology™, adapts to the
shape of the surrounding ear
canal when in your ear, and
returns the earplug to its
original shape when
removed. 100/Box



Part#	Description
KCP20378	V30 Nemesis* CSA Safety Glasses, Clear Lenses with Black Frame
KCP20379	V30 Nemesis* CSA Safety Glasses, Clear Anti-Fog Lenses with Black Frame
KCP20380	V30 Nemesis* CSA Safety Glasses, Smoke Mirror Lenses with Black Frame
KCP20381	V30 Nemesis* CSA Safety Glasses, Indoor/Outdoor Lenses with Black Frame
KCP20382	V30 Nemesis* CSA Safety Glasses, Blue Mirror Lenses with Black Frame
KCP20386	V30 Nemesis* CSA Safety Glasses, Bronze Lenses with Camo Frame



KCP20525
Wildcat Safety Goggle Clear
Anti-fog Lens. Adjustable side
vents to help increase airflow.
Extreme heat resistance - will
not melt, drip or ignite at
350™°F for five minutes.
Lightweight and comfortable
with a pivot headband that
allows for optimal placement



KCP20529
Wildcat Safety Goggle.
IRUV 5.0 Anti Fog Lens
Adjustable side vents to
help increase airflow.



KCP97431 –KCP97434
Jackson Safety* G60 Purple Nitrile*
Cut Resistant Gloves 9.0-L
ANSI Level 3 cut resistance,
CPPT = 1150g
More tapered coating on the fingertips
for added dexterity. Breathable fabric
with flexible dotted palm provides
excellent grip and comfort
Ambidextrous design



- Aluminum valves, handles and levers are lightweight yet extremely durable and corrosion resistant
- Heavy duty plated steel siphon tubes are threaded versus crimped providing a secure connection
- Large neck opening more easily accommodates recharge
- Colour coded nameplates make it easier to identify agent type and applications
- Engineers grade polymer hose strap does not bend or scratch cylinders.
- Square thread design makes removing and installing valve quick and easy.
- Large pull pin and handles are easy to operate with gloves

Part	Description
408-21008346	1A,10B:C Fire Extinguisher With Vehicle Bracket 2.5 LB
408-21008347	3A,40B:C Fire Extinguisher With Wall Bracket 5.5 LB
408-21008348	4A,60B:C Fire Extinguisher With Wall Bracket 10 LB
408-21008349	6A,80B:C Fire Extinguisher With Wall Bracket 20 LB



KCP58512 - KCP58516

KLEENGUARD* A20 Breathable Particle Protection Coveralls. Med Style: Hooded - Zipper front, Elastic wrists & ankles, Elastic across the back Features: - REFLEX* design - Patented MICROFORCE™ Barrier SMS fabric - Barrier protection against dry particulates - Seamless front to provide more protection in the primary exposure areas - NFPA 99 Compliant Antistatic - Zipper flap - Elastic in the back - Denim Blue TYPICAL USES: Laboratories; Decontamination modesty garment; Remediation; Pesticides; Heavy dust environments



KCP44323 – KCP44326

KLEENGUARD* A40 Liquid & Particle Protection Coveralls. Breathable, microporous film laminate. Better liquid and particulate barrier than TYVEK™ Low in lint. Passes NFPA 99 criteria for antistatic materials Made with breathable material for comfort



KCP45023 – KCP45026

KLEENGUARD* A60 Bloodborne Pathogen & Chemical Splash Protection Coveralls Protection against bloodborne pathogens in forensic or other environments where exposure to blood is possible. KLEENGUARD* A60 also provides protection against some chemicals Hooded - Zipper front with storm flap; Elastic wrists & ankles; Elastic across the back



KCP55080 – KCP55084

PURPLE NITRILE™ Exam Gloves, Ambidextrous. Custom design enhances comfort and fit, and textured fingertips improve wet and dry grip. Designed as an alternative for those who may have a Type 1 hypersensitivity to natural rubber latex proteins. Latex-free. Non-sterile. Powder-free. Single use only.



KCP90095 – KCP90099

Kleenguard* G10 Artic Blue Nitrile Gloves. Advanced formulation delivers superior strength with enhanced tactile sensitivity. This enables wearers to better feel the shape and texture of objects for increased speed and accuracy across a wide range of industrial jobs. 2 mil thickness, 9.5" length Powder-free



KCP57370 – KCP57374

Kleenguard Blue Nitrile Powder Free Glove. (100/Box) Provides hand protection while eliminating the type one allergic reactions associated with natural rubber latex proteins. The material provides an added degree of durability compared to latex, while textured fingertips provide enhanced grip and dexterity. CFIA approved – Size XS-XL



KCP36811

KLEENGUARD* A10 Light Duty Shoe Covers. Blue - One Size Fits All Features:

- Fully elasticized
- Low skid
- Light blue color
- Lightweight polypropylene material





127-1702

Big Jake®, A+ Side Leather, 2.75" Safety cuff, DuPont™ Kevlar® Sewn & lined. An 8 ounce jersey palm lining, cotton canvas back, and rubberized safety cuff keep your hands cool, comfortable, and safe while you work. M- X-Large



127-12010

Grade Shoulder Leather, Assorted Fabric, 2.5" Rubberized Safety Cuff is an excellent economy cowhide leather palm option S- X-Large



127-3202

Drivers glove, Economy Grade Unlined Grain Cow Leather, Straight Thumb. The 3202 drivers gloves feature; unlined cow grain leather, shirred elastic back, cotton hemmed, and a straight thumb pattern. S-XXL



611-2003

Classic, .35mm PVC/Polyester 3 pc suit, Detachable Hood, Snap Front Jacket & Bib Pant, Yellow L- 7X



611-3882

Dominator, .42mm PVC/Polyester/PVC, 2 pc suit, jacket w/inner sleeve & zipper front, Bib pants, This material is treated to be limited flammability and has been tested in accordance with the ASTM D-6413 test method S-7XL

The FastFit® is a toolbox must-have. Form-fitting stretch panels between your fingers provide a snug fit & the elastic cuff offers easy on/off flexibility between tasks. The anatomically designed two-piece palm eliminates material bunching for an exceptional fit when working with hand tools. Breathable TrekDry® material form-fits the back of your hand & helps keep them cool & comfortable as you work through the day



Mechanix Wear Fast Fit glove

Black Standard Pack 10
484-MFF-05-009 - Medium
484-MFF-05-010 - Large
484-MFF-05-011 - X-Large
484-MFF-05-012 - 2X



Mechanix Wear Fast Fit glove

Hi-viz Yellow Standard Pack 10
484-SFF-91-009 - Medium
484-SFF-91-010 - Large
484-SFF-91-011 - X-Large



Mechanix Wear Fast Fit glove

Hi-Viz Orange Standard Pack 10
484-SFF-99-009 - Medium
484-SFF-99-010 - Large
484-SFF-99-011 - X-Large

The Original's durable synthetic leather palm and breathable TrekDry® back-of-hand combine to create the ultimate tool for hardworking hands. A new tapered TPR closure and increasingly stronger hook and loop provide a secure fit to the wrist. With a gamut of practical uses

The M-Pact® delivers full-coverage hand protection with an impact-absorbing Thermoplastic Rubber (TPR) knuckle guard and dedicated finger guards that shield the top of your hand while you work. The dual-layer internal fingertip construction reinforces your thumb and index finger to improve abrasion resistance where you need it most



Mechanix Wear Original Series Glove

484-MG-02 - Red S-2X
484-MG-05 - Black XS-3X
484-SMG-91- Yellow S - 2X
484-SMG-99- Orange S-2X



Mechanix Wear Original series glove

484-MPT-58 - Black S-3X

M-Pact® 2 protects your hands from impact, abrasion and hand fatigue reduces impact and vibration. Anatomically designed for an unbelievable fit features an accordion knuckle with EVA foam padding and Thermoplastic Rubber (TPR) finger guards to protect against blunt force impact

The M-Pact® CR5A3 protects working hands with CE level 5 and ANSI A3 cut resistance in the workplace. The palm and fingers are protected by an internal layer of high-tenacity Armortex® to prevent abrasions and lacerations when working with sharp tools and sharp materials



Mechanix M-Pact 2

484-MP2-55 - Black S-3X



Mechanix M-Pact CR5A3 Series Glove

484-SMP-C91 - S-2X



by Honeywell



MIL213WLS-Z7/6FTYL
Web Lanyard 6-ft. length, 2 locking snap hooks, yellow



MIL216M-Z7/5FTGNC
5Ft Manyard II Lanyard With Two Locking Snap Hooks



MIL219WRS-Z7/6FTYLC
Miller Manyard Single Leg, Yellow Lanyard. One Snap And One Rebar Hook. 6 Ft. Long



MIL233MK-Z7/6FTBKC
Single Leg Manyard. Made Of Kevlar W/Snap Hook And Web Loop.



MILT5111-Z7/4FTAFC
4' Titan tubular web shock absorbing lanyard
MILT5111/6FTAFC
6' Titan tubular web shock absorbing lanyard



MILT5112/6FTAFC
6' Titan tubular web shock absorbing lanyard w/2-1/4" locking rebar hook



MIL913TWLS-Z7/4FTGNC
4Ft Web Teflon Lanyard W/2 Locking Snap Hooks



MILMFL-11-Z7/6FT
Unit Connector- Aluminum Twist-Lock Carabiner



MILPFL-4-Z7/9FT
Unit Connector: Carabiner and Swivel Shackle; Lanyard End Connector: Locking Snap Hook



MILRL65SS-Z7/65FT
MightyLite Cable Self-Retracting Lifeline 65-ft. stainless steel wire rope (3/16") lifeline



MFLC-12-Z7/6FT
Miller Twin Turbolite Personal Fall Limiter W/ G2 Connector & Aluminum Rebar Hooks- 6 Ft



MILAC-QC-BDP/S/MGN
Miller AirCore Harness w/Aluminum hardware, side D-rings, Lumbar Pad and Removable Belt Quick-Connect chest and leg Small /Medium



MILE650QC/UGN
DuraFlex Ultra Harness with Elastomer Webbing and Quick-Connect Buckles. Quick connect buckle chest strap and legs straps; and Comfort D-pad - universal



MILP950QC/UGN
DuraFlex Ultra Harness with Tubular Webbing and Quick-Connect Buckles. Quick-connect buckle chest strap and legs straps; and Comfort D-pad. - universal



MILRDT-QC/UBK
Revolution Harness with DualTech Webbing Quick-Connect Buckle Legs - universal



MILRKNARRL-QC/UBK
Revolution Harness with Kevlar-Nomex Webbing Arc Rated - Quick-Connect Buckle Legs - rescue loop - universal



MILT4507/UAQ
Titan Non-Stretch Harness. Sliding back D-ring; side D-rings; tongue buckle legs, mating buckle chest and shoulder straps; sub-pelvic strap - universal



MIL650CN-BDP/UGN
Contractor Harness with Combination Back D-ring. Pad/Shoulder Pads Friction buckle shoulder adjustments, MB chest adjustments, TB legs adjustments, back/shoulder pad combo, back lumbar pad, side D-rings, and removable belt- Small/Medium



MILDH-1
Portable Confined Space System. Four Piece Hoist System (DH-3 and DH-4) with 65' ManHandler winch. The Miller DuraHoist Portable Confined Space System provides safe, lightweight and portable solutions for manhole and confined space entry/retrieval and fall arrest applications.

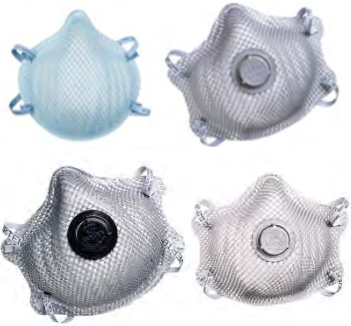

Part	Description	U/M
MM2200N95	2200 Series N95 Particulate Respirator	20/Box
MM2300N95	2300 Series N95 Particulate Respirator with exhale valve Medium/Large	10/Box
MM2301N95	2300 Series N95 Particulate Respirator with exhale valve Small	10/Box
MM2307N95	2300 Series N95 Particulate Respirator with exhale valve Low Profile	10/Box
MM2310	N99 Premium Particulate Respirator	10/Bag
MM2400N95	N95 Particulate Respirator Plus Nuisance Ozone/Organic Vapours	10/Bag
MM2700N95	N95 Particulate Respirator with Handy Strap Medium/Large	10/Box
MM2740N95	N95 Particulate Respirator with Handy Strap & Ventex Valve Medium/Large	10/Bag



MM4200 Medium/Large
MM4201 Small
 AirWave N95 Disposable Respirator 10/Box
 The outstanding performance of AirWave® is due to its patented, wave design technology. It allows more airflow in and out of the respirator for cool comfort and easier breathing.



MM6200
 Exclusive iridescent color and curvy shape for great looks. Headband made of lightweight plastic for comfort all shift long. Six different adjustment points provide a custom and comfortable fit for most head sizes.



MM6404
 Rockets® Earplugs Coded in Bag 50 Pairs per Box NRR 27 protection. Rockets® reusable earplugs are designed to give you a great grip. The easy grip handle lets them easily slip into the ear and it's brightly colored for compliance checks.



MM6506
 The new Jazz Band® has been redesigned with increased protection and comfort in mind. NRR 25 Banded Hearing Protector with Optional Neck Cord.



MM6604 Uncorded. 200 Pairs/Box
MM6654 Corded 100 Pairs/Box
 SparkPlugs® earplugs are made of extra-soft, extra light foam.



MM6800
 Pura-Fit Disposable Earplug Un-Corded right color for easy compliance checks. Long length for easy fitting and removal. 200 Pairs/Box



MM6644
 SparkPlugs® PlugStation®, 250 Pairs/Dispenser 6 Dispensers/case



MM6645
 SparkPlugs® PlugStation®, 500 Pairs/Dispenser 4 Dispensers/case



MM6647
 PlugStation® with Goin' Green®, 500 Pairs/Dispenser, 4 Dispensers/Case



MM6845
 Pura-Fit® PlugStation®, 500 Pairs/Dispenser 4 Dispensers/case



MM6620
 Goin' Green Foam Earplug 100% PVC-Free®. Highest independently tested NRR 33. Look for the exclusive colored streaks and swirls as a symbol of Moldex quality.



MM7940
 P100 Filter Disk for 7000 Series Half Mask & 9000 Series Full Face Respirators



MM9001 - Small
MM9002 - Medium
MM9003 - Large
 9000 Series Full Face Respirator. At less than 13 ounces, the 9000 Series respirator is ultra-lightweight.



MSA10115836

V-Gard™ Visor Provides maximum UV protection. Shape accommodates cap-mounted earmuffs. Suitable for most applications where impact hazards exist. Wider design for improved resistance to impact and splash hazards



MSA10034487

Sound Control SH Soprano Earmuff Kit for Full Brim Hat. Easy ear cup height adjustment. Soft ear cup material for extended wear. Three distinct wearing positions for ease of use NRR 25Db. Hard cap not included



MSA10061272

SoundControl HPE Cap Model, Use with MSA Slotted Caps, complete with brackets. Designed specifically for very high noise levels and is ideal for airfields, power plants and other areas with intense noise. Hard cap not included



MSA10116627

V-Gard Accessory System Universa Visor Frame, 11-1/4 x 5 1/2, Black. Features a heavy-duty, flat, rubber strap can be used with slotted and non-slotted MSA helmets. Perfect compatibility with many half-mask respirators



MSA10153384

Fas-Trac III Replacement Suspension, 4-pt Std-sized for Thermalgard and Topgard Fas-Trac™ III ratchet suspension and flush rear lug attachments eliminate pressure points. Graspable ratchet with ultra-smooth rotation and steadfast hold. Three levels of nape strap adjustment for customized fit



The MSA V-Gard Helmet, with its distinctive trademark "V" design, is a world recognized brand known for comfort, quality, and durability

Part	Description
MSA475358	Cap V-Gard White Fas-Trac Susp
MSA475359	Cap, V-Gard, Blue, Fas-Trac Susp
MSA475360	Cap V-Gard Yellow Fas-Trac Susp
MSA475361	Cap V-Gard Orange Fas-Trac Susp
MSA475362	Cap V-Gard Green Fas-Trac Susp
MSA475363	Cap V-Gard Red Fas-Trac Susp



MSA10104254

Freedom Series V-Gard Hard Hat, Full Brim, Camouflage. Featuring Fas-Trac™ Suspension. Industrial-strength head protection that's lightweight yet durable. Slotted for better impact resistance and personal comfort



MSA10103908
Cap, V-Gard, Standard, Camouflage, Ratchet Suspension



Part #	Description
MSA475382	Cap Topgard Orange Fas Trac®
MSA475388	Hat Topgard Gray Fas Trac®
MSA475389	Hat Topgard Blue Fas Trac®
MSA475390	Hat Topgard Orange Fas Trac®
MSA475391	Hat Topgard Green Fas Trac®
MSA475392	Hat Topgard Red Fas Trac®
MSA475393	Hat Topgard Ratchet White
MSA475394	Hat Topgard Black Fas Trac®



MSA10129327

SoundControl SH for Full Brim Hat (NRR 25 dBA). Spring design offers low pressure and a high level of comfort



MSA10107602

Altair 4X Multigas Detector. Extremely durable Multigas Detector that simultaneously measures up to four gases from a wide range of XCell(R) sensor options including combustible gases, O₂, CO, H₂S, SO₂ and NO₂



MSA815366

MSA815369

Cartridges Advantage GME-P100 2/PKG are lightweight, low profile performance. Also fits 420 Half-Mask Respirators and 1000, 3000 and 4000 Full-Mask Respirators



MSA10072475

Workman® Energy-Absorbing Lanyard



MSA472859

Adapter Assembly Welders Clip On Ultravue facepiece



MSA10115855

V-Gard® Propionate Visors for Chemical and Splash. Provide impact protection, and are good for those applications where chemical splash hazards also exist



MSA10072479

Workman® Harness with Chest and Leg Buckles and Back D-Ring



MSA10115861

V-Gard® Visors for Welding, Cutting and Brazing Applications



MSA815692

Respirator Advantage 2-Pc Neck 200 LS Facepieces, Medium, 2-Piece Neckstrap. The lighter and softer facepiece is made from a clear blue formulation of thermoplastic rubber to give the workers more comfort and stability



Norguard's Class-A Fall Arrest Harness utilizes a 1—3/4" polyester webbing that is supremely strong and durable. This harness incorporates a dorsal D-ring certified for fall arrest, 5 independent points of adjustment, and is compliant with all CSA, OSHA, and ANSI regulations.

Part	Size	Description
NGDNPH-28	Universal	Fall Arrest Harness w/ Pass-Thru Legs, Back D-Ring
NGDNPH-29	Universal	Fall Arrest Harness w/ Tongue Buckle Legs, Back D-Ring



The Seraph Construction Harness is specially designed with six points of adjustment, dorsal and side D-rings, and improved flexibility in the shoulder and back for added comfort. It includes an integrated impact indicator that clearly identifies if it has been exposed to forces of a fall, lanyard keepers with the dual function of securing excess webbing and serving as retrieval hoists, and "Quick-Adjust" friction torso buckles for fast and easy resizing. The Seraph Construction Harness is ideal for the standard construction worker, and is lightweight and incredibly durable.

Part	Size	Description
NGD11173CSA	M - L	Seraph Construction Harness w/ Leg Tongue Buckles

Some of Norguard's most popular products, our Noryard line of lanyards are manufactured lengths of 4' – 6' and with a variety of connector options, and come with a fall arrest indicator. Built with an integrated energy absorber from durable, 1" tubular webbing, Noryards are practical and effective lanyards for a multitude of jobs.



Part	Size	Description
NGDNOR-01-01-6	6'	Noryard with Double Lock Snap Hook Ends
NGDNOR-01-N314-6	6'	Noryard with Snap Hook & N314 Hook Ends
NGDNOR-01-N314-6Y	6'	Double Legged Noryard w/ Snap Hook & N314 Hook 'Y' Ends



Norguard's Roofer's Kits include a NPH-28 Harness, NRK200-S Rope Grab with 2' Energy Absorber, NRA-090 Roof Anchor, 25' Prosteel Rope, and a 5 gallon Storage Pail. These kits are fully customizable with a variety of rope lengths and anchor options, and are ideal for nearly any roofing job.

Includes:

- NPH-28 Harness
- NRK200-S Rope Grab /w 2ft Energy Absorber
- NRA-090 Roof Anchor /w nails
- PROSTEEL rope w/ snap hook at one end (sizes vary between models)
- 5 gallon bucket

Part	Size	Description
NGDNRK-200S-50	M - L	Seraph Construction Harness w/ Leg Tongue Buckles

Norguard's Cable SRL with retrieval operation is a Type 3 SRL, which features lightweight and durable thermoplastic housing. Capable of both arresting a fall in the event of slipping down ladder, or method of access, and raising the worker from a confined space in the event that a rescue is needed. This SRL is an excellent choice for rescue and retrieval applications.

Part	Size	Description
NGD90576	60'	Thermoplastic housing, galvanized cable SRL w/ Retrieval Operation

Norguard's Prosteel Rope is some of the toughest, most durable, and most versatile ropes on the market. Available in a variety of lengths and connector configurations, this 5/8" diameter rope is highly resistant to mildew, abrasion, and ultra-violet light, has excellent gripping ability, and minimizes elongation when exposed to forces of fall arrest.

Part	Size	Description
NGD62145-01-50	50'	Co-Polymer Prosteel Rope w/ Double Lock Snap Hook End





North Zone Hard Hat

Setting a new standard for hard hat comfort. Our North zone hard hat is so comfortable, stable and lightweight your workers won't want to take it off. The North Zone has a sleek, modern shell combined with a patented suspension design featuring multiple adjustment points for size, height and snugness; easily removable and replaceable.

Part	Description		
NORN10R010000	Hat N10 Ratchet White	NORN10010000	Hat N10 Quick Fit White
NORN10R020000	Hat N10 Ratchet Yellow	NORN10020000	Hat N10 Quick Fit Yellow
NORN10R030000	Hat N10 Ratchet Orange	NORN10030000	Hat N10 Quick Fit Orange
NORN10R040000	Hat N10 Ratchet Green	NORN10040000	Hat N10 Quick Fit Green
NORN10R050000	Hat N10 Ratchet Red	NORN10050000	Hat N10 Quick Fit Red
NORN10R070000	Hat N10 Ratchet Sky Blue	NORN10070000	Hat N10 Quick Fit Sky Blue



NOR54001

North 5400 full facepiece, elastomeric, with four strap headband, dual cartridge connectors for N series. Size Medium/Large.



NOR550030M

5500 Series Low Maintenance Half Mask Respirators. Made of extremely soft non-allergenic elastomer for comfort and fit. Medium



NOR7003

Respirator Refresher Wipe Pads Alcohol-free and will not damage facepiece materials. Individually wrapped to hold moisture. Stored in a convenient box 100/Box



NOR7580P100

P100 any particulates filter (HEPA) - 99.97% minimum filter efficiency. Compatible with all North facepieces - Sold 2/pack



NOR75SCP100L

Defender: Organic Vapor, Chlorine, Hydrogen Chloride, Sulfur Dioxide and P100 Cartridge/Filter Combination



NOR75FFP100NL

P100 low profile, flexible filter with odor relief from nuisance levels of organic vapors, acid gases and ozone



NOR7583P100L

Organic Vapor, Chlorine, Hydrogen Chloride, Sulfur Dioxide, Hydrogen Fluoride, Chlorine Dioxide And P100 Cartridge/Filter Combination



NOR75SCL

Defender Respiratory Lowprofile Cartridge. Easy user seal check Lower profile so cartridges don't intrude into the work zone



NORN75001L

Organic Vapor Respirator Cartridges



NOR760008A

Full Facepiece Silicone 5 Strap Head Harness with Dual Cartridge Connectors Medium/Large



NOR770030S - Small
NOR770030M - Medium
NOR770030L - Large
Half Mask Silicone With Dual Cartridge Connectors



NOR80836A

Peel-Away Windows For Use With 5400, 7600 and 7800 Series. Full Facepieces Convenient, disposable lenses. Simply peel away and dispose



NORA2634

Arm Protection - Whiting + Davis Metal Mesh Stainless steel double sleeve w/polypropylene strap harness (wrist to shoulder) - (XXS, XS, S, M, L, XL, XXL)



NORCP5004

Aluminum Faceshield Bracket High Heat Resistant. Fits the Peak, K2 Short Peak, K2 and Matterhorn Hard Hat



NORSB470

Terry Cloth Sweat Band with Velcro Closure. Universal Fit. 10 Per Pack.



NORBP1002

Backpack Adapter to convert your north 5500, 7700, 5400 or 7600 facepiece into a BP1000 series respirator.



NOR75125C

Servus® PRM II, PVC, Steel Toe, Steel Midsole Safety Footwear 15 in (38.1 cm) Safe-Step™ midsole - removable cushion insole - ergonomic footbed - Men's whole sizes: 7 - 14



NORT56005B

The Edge S/Glasses, Black & Grey Frame, Clear Lens - 10 Each



PYR-HCW100
Box with 100
Alcohol Free
Hygienic Wipes



PYR-GG504TSHIELD
Capstone Goggle
Direct/Indirect Body Gray
Frame/Clear Anti-fog Lens



PYRAMEX



PYR-SB5621D
Goliath® Black Frame Gray
Polarized Lens



PYR-SB5645D
Goliath® Black Frame Ice
Orange Lens



PYR-SB5665D
Goliath® Black Frame Ice
Blue Mirror Lens



PYR-SW5655D
Goliath® White Frame Sky
Red Mirror Lens



PYR-SBG5020DT
Highlander Plus™ Black-Gray
Frame Gray Anti-Fog Lens



PYR-SB7010SDT
I-Force® Black Frame
Clear Anti-Fog Lens



PYR-S5810S
Itek® Clear Frame Clear
Lens



PYR-S4110S
Intruder® Clear Hardcoated Lens



PYR-S7210ST
Provoq™ Clear Frame Clear
Anti-Fog Lens



PYR-GB1880ST
V2G® Black Frame
Indoor/Outdoor mirror Anti-Fog



PYR-GB1810ST
V2G® Black Frame Clear
Anti-Fog



PYR-SB1810R25
V2® Readers Black Frame
Clear Lens + 2.5



PYR-S2510S
Ztek® Clear Frame Clear Lens



PYR-S2560S
Ztek® Infinity Blue Frame
Infinity Blue Lens



PYR-S2510SN
Mini Ztek® Clear
Frame Clear Lens



PYR-S2517SN
Mini Ztek® Pink Frame Pink Lens



NITECH® EDT
Examination Glove (5 mil)

Manufactured from a patented blend of premium quality synthetic materials; exclusive to Ronco

- Impressive strength and elasticity
- Exceptional touch sensitivity and dexterity
- Superior durability • Powder free
- 100% latex free; reduces risks associated with allergic reactions
- Blue colour

RON365	Small
RON375	Medium
RON385	Large
RON395	X Large



RONCO LE2
Latex Examination Glove (4 mil)
Available in lightly powdered (LP) or powder free (PF), RONCO LE2 is an examination glove made from premium quality latex. It is ideal for food processing, dental, healthcare, pharmaceutical, veterinary or laboratory environments

RON1523	Small
RON1533	Medium
RON1543	Large
RON1553	X Large



RONCO NITRILE N2

- 100% nitrile
- Excellent strength
- Available as lightly powdered or powder free
- 100% latex free, reduces risks associated with allergic reactions
- Blue colour

RON963	Small
RON973	Medium
RON983	Large
RON993	X Large

RON964	Small
RON974	Medium
RON984	Large
RON994	X Large

SENTRON™ 4
Nitrile Examination Glove (4 mil)
Highly resistant to hydrocarbon oils, fats, detergents and solvents. SENTRON™ 4 is perfect for industrial applications that require a tough disposable glove

RONCO BluRite Plus

• Manufactured from premium quality nitrile • 100% accelerator free, reduces risks of Type IV allergic reactions • Excellent resistance to a wide variety of chemicals • Powder free • 100% latex free, reduces risks associated with allergic reactions • Blue colour

RON966	Small
RON976	Medium
RON986	Large
RON996	X Large

BLURITE™ XPL Nitrile Examination Glove (8 mil), Extra Long

RON968	Small
RON978	Medium
RON988	Large
RON998	X Large

For eXtra Protection in a Long glove, RONCO Blurite™ XPL provides an excellent impermeable barrier of protection against bio-hazardous and infectious materials

RON170-21

Bouffant Caps
Non Woven White
100/Bag
10 Bags/Case



RON170G-21

Bouffant Caps
Non Woven Green
100/Bag
10 Bags/Case



RON170Y-21

Bouffant Caps Non Woven Yellow
100/Bag
10 Bags/Case



A700 Series Eyewear, Clear Polycarbonate Hard Coat Lenses, Clear Frame Flexible temples with soft padded temple tips. Molded nose bridge for comfortable fit

Uvex Seismic Sealed Eyewear

Contemporary style that can be worn with temples or headband. Provides protection against impact, sun, wind, and debris. Ideal for high-particulate environments such as grinding, chipping and sanding

Part#	Description
UVXA700	Clear Frame Clear Lens, Anti-scratch Coating
UVXA701	Gray Frame TSR Gray Lens, Anti-scratch Coating
UVXA702	Amber Frame Amber Lens, Anti-scratch Coating
UVXA703	Gray Frame Blue Mirror Lens, Anti-scratch Coating
UVXA704	Gray Frame I/O Silver Lens, Anti-scratch Coating
UVXA705	Clear Frame Clear Lens, Fog-Ban Anti-fog Coating

Part#	Description
UVXS0600X	Black Frame Clear Lens, Anti-scratch Coating
UVXS0601X	Black Frame Espresso Lens, Uvextra Anti-fog
UVXS0602X	Black Frame Amber Lens, Uvextra Anti-fog
UVXS0604X	Black Frame SCT-Reflect 50 Lens, Uvextra Anti-fog
UVXS0605X	Black Frame SCT-Gray Lens, Uvextra Anti-fog

Uvex Skyper

Wrap-around protective eyewear offers exceptional comfort, protection and fit. Adjustable temple length and lens inclination

Uvex Astro OTG 3001

Same adjustability features as the Astrospec 3000 with attractive OTG (over-the-glass) styling

Part#	Description
UVXS1931X	Black Frame Clear Lens, Anti-scratch Coating
UVXS1932X	Black Frame Espresso Lens, Uvextra Anti-fog
UVXS1933X	Black Frame Amber Lens, Uvextra Anti-fog
UVXS1934X	Black Frame SCT-Reflect 50 Lens, Uvextra Anti-fog

Part#	Description
UVXS2500C	Black Frame Clear Lens, Uvextreme Anti-fog Coating
UVXS2501	Black Frame Espresso Lens, Uvextra Anti-fog
UVXS2504	Black Frame Gray Lens Ultra-dura Anti-scratch Coating
UVXS2509	Black Frame SCT-Gray Lens, Uvextra Anti-fog

Uvex Genesis

Wrap-around lens provides exceptional peripheral vision and protection. Flexible fingers adjust to most nasal profiles. Elastomer browguard deflects impact. Adjustable temples and lens inclination.



Part#	Description
UVXS3200	Uvex Genesis Black Frame Glasses, Clear Ultra-dura
UVXS3200X	Uvex Genesis Black Frame Glasses, Clear Uvextreme
UVXS3201X	Uvex Genesis Black Frame Glasses, Espresso Uvextreme
UVXS3204	Uvex Genesis Black Frame Glasses, SCT-Reflect 50 UD
UVXS3208	Uvex Genesis Black Frame Shade 3.0 Infra-dura Lens, Ultra-dura Anti-scratch Coating
UVXS3240	Uvex Genesis Blue Frame Ultra Dura Clear Lens
UVXS3240X	Uvex Genesis Vapour Blue Frame Glasses, Clear Uvextreme
UVXS6902X	Uvex Genesis Replacement Lens, Amber / Uvextreme AF
UVXS6900X	Uvex Genesis Replacement Lens, Clear Uvextreme
UVXS6904	Uvex Genesis Replacement Lens, SCT-Reflect 50 / Ultradura

Uvex Protégé

Floating lens design offers flexibility and fit. Ultra-lightweight at 27.5 grams for all day comfort. Secure wrap-around brow expands to fit a wide range of users.

Part#	Description
UVXS4200	Uvex Protégé Black Metallic Frame Glasses, Clear Anti-Scratch Coating
UVXS4200X	Uvex Protégé Black Metallic Frame Glasses, Clear Uvextra Anti-Fog Lens
UVXS4201X	Uvex Protégé Black Metallic Frame Glasses, Grey Uvextra Anti-Fog Lens
UVXS4202	Uvex Protégé Black Metallic Frame Glasses, SCT-Reflect 50 Lens Anti-Scratch



UVXS3960C
Uvex Stealth Futuristic, low profile design for chemical splash and impact. Toric lens provides superior optics and peripheral vision. Quick adjust headband Clear Lens, Uvextreme Anti-fog Coating



UVXS301CS
 Uvex Ultra-spec 1000 Wrap-around unilens design with solid sideshields. Ideal safety eyewear for visitors.



UVXS462
 Uvex Cleaning Tissues Specifically formulated for anti-fog and scratch resistant hardcoat lenses 500/Box



UVXS463
 Uvex Lens Cleaning Solution Spray Bottle 16 oz. Specifically formulated for anti-fog and scratch resistant hardcoat lenses.



UVXS468
 Uvex Lens Cleaning Moistened Towelettes Specifically formulated for anti-fog and scratch resistant hardcoat lenses 100/Box

Uvex Bionic

A revolutionary face shield designed for rugged jobs. Extremely lightweight and highly adjustable for all-day comfort it's perfect for workers exposed to impact, chemical splash, and airborne debris.



Part	Description	Coating	Tint
UVXS8500	Uvex Bionic Black Matte Faceshield	Visor Coating - Uncoated	Visor Tint - Clear PC
UVXS8510	Uvex Bionic Black Matte Faceshield	Visor Coating - Anti-fog /Hardcoat	Visor Tint - Clear PC
UVXS8550	Uvex Bionic Replacement Visor	Visor Coating - Uncoated	Visor Tint - Clear PC
UVXS8555	Uvex Bionic Replacement Visor	Visor Coating - Anti-fog/Hardcoat	Visor Tint - Clear PC
UVXS8560	Uvex Bionic Replacement Visor	Visor Coating - Uncoated	Visor Tint - Shade 3.0
UVXS8565	Uvex Bionic Replacement Visor	Visor Coating - Uncoated	Visor Tint - Shade 5.0
UVXS8580	Uvex Bionic Replacement Sweatband		
UVXS8590	Uvex Bionic Hard Hat Adapter		
UVXS8595	Uvex Bionic Ratchet Suspension		

Enviro Cone

- New super cone
- High visibility and long-term durability
- Superior hot and cold weather performance
- No cracking / breaking down to -25° F
- More stable than 7 or 10lb PVC cones because 80% of the weight is in the base
- Easy Grip Groove for quick deployment and retrieval
- Made from 80% recycled material and can be recycled again
- Made in North America



375-16018-NSWB-3 - Enviro-cone, 18 inch 3 lb With No Reflective Collars
375-16028-NSWB-7 - Enviro-cone, 28 inch 7 lb With No Reflective Collar

Delineator Tube

Part	Description
375-42133-TRU12HIP	GRABBER 1 -- 42 Inch Delineator Tube With 2-3 inch Reflective Collars and 12 LB base
375-42133-TRU212HIP	GRABBER II -- 42 Inch Delineator Tube With 2-3 inch Reflective Collars and 12 LB base



Part#	Description
375-16018-HIWB-3	18 inch 3 lb W/1-6 in Reflect Collar
375-16018-NSWB-3	18 inch 3 lb W/No Reflect. Collars
375-16028-HI4WB-7	28 inch 7 lb W/1-4 in Reflect. Collar
375-16028-L-H14WB-7	28 inch 7 lb W/1-4 in Reflect. Collar Lime
375-16028-HIWB-7	28 inch 7 lb W/(1) 4 inch & (1) 6 inch Reflect. Collar
375-16028-HIWB-10	28 inch 10 lb W/4 inch& 6 inch Reflect. Collar



Grabber®



SAFETY



813-720DGU
 Gray PU Palm Coated Speckle Gray HPPE Gloves. Rugged HPPE fiber is 10 times stronger than steel and 40% stronger than blended fabrics. Excellent cut protection in a comfortable glove XS-3XL



813-990KOT
 Keystone Thumb Select Grain Cowhide Driver Gloves. Select grain cowhide leather driver glove. Extra protection by keeping safety in mind with Hi-Vis orange at the fingertips and a Hi-Vis reminder to "WATCH YOUR HANDS". Keystone thumb is durable and allows for the best flexibility XS-2XL



WESTCHESTER
 PROTECTIVE GEAR®

813-2905
 3 Mil Food Grade Powder Free Blue Nitrile Gloves. Powder free food grade disposable nitrile gloves are perfect for individuals with latex allergies. Stretches for snug sensitive fit and maximum dexterity. Textured for added grip. Great for working with oils and solvents. S,M,L,XL



813-5150
 Grain Leather Palm Rubberized Cuff Gloves. Top-grain cowhide leather palm with fabric back provide reliable hand protection in general-duty applications. 2 1/2" rubberized safety cuff provides extra protection. Leather pull tab for easy on and off. Color coded cotton hem for easy size identify XS-3XL



813-6130
 Ironcat® Deerskin Split Leather TIG Welding Gloves. Split deerskin combines a soft feeling with a snug fit ideal for TIG welding. Soft leather allows wire to pass freely over glove. 4" cuff protects hands and lower arms from burns. S-XL



813-9010-L
 Ironcat® Shoulder Split Cowhide Welding Gloves. Shoulder split cowhide provides excellent protection in high heat welding conditions at an affordable price. 14" length protects hands and arms from sparks and spatter. Large

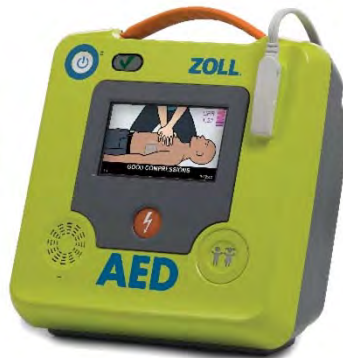

ZOLL®

Part	Description
ZOL-AEDPACE	ZOLL AED Plus w/ AED Cover English 20100000102011060
ZOL-AEDPPIE	ZOLL AED Plus w/ Pro Interface English 20100000302011060
ZOL-AEDPGCF	ZOLL AED Plus w/ Graphical Cover French 20100000101011260
ZOL-AEDPACF	ZOLL AED Plus w/ AED Cover French 20100000102011260
ZOL-AEDPPIF	ZOLL AED Plus w/ Pro Interface French 20100000302011260
ZOL-FAAEDPACE	ZOLL Fully Auto. AED Plus with AED Cover English 21400710702011060
ZOL-FAAEDPGCF	ZOLL Fully Auto AED Plus with Graphical Cover French 21400710701011260
ZOL-SAAED3-E	ZOLL Semi-Automatic AED 3® - English 8501-001101-06
ZOL-SAAED3-F	ZOLL Semi-Automatic AED 3® - French 8501-001101-26
ZOL-FAAED3-E	ZOLL Fully Automatic AED 3® - English 8501-001102-06
ZOL-FAAED3-F	ZOLL Fully Automatic AED 3® - French 8501-001102-06
ZOL-8000-0855	Standard Metal Wall Cabinet (9" deep) designed to hold AED Plus in a carry case with spare electrodes





Speedglas™



Part #	Description
3MH70-0715-1070-8	3M™ Speedglas™ Welding Helmet 9100, 06-0100-10, with 3M™ Speedglas™ Auto Darkening Filter 9100V, Shades 5, 8-13
3MH70-0715-1071-6	3M™ Speedglas™ Welding Helmet 9100 with Auto Darkening Filter 9100V, Welding Safety 06-0100-10SW with side windows
3MH70-0715-1072-4	3M™ Speedglas™ Welding Helmet 9100 with Auto Darkening Filter 9100X, Welding Safety 06-0100-20/37172(AAD)
3MH70-0715-1048-4	3M™ Speedglas™ Welding Helmet 9100 with Auto Darkening Filter 9100X, Welding Safety 06-0100-20SW with side windows
3MH70-0715-1073-2	3M™ Speedglas™ Welding Helmet 9100 with Auto Darkening Filter 9100XX, Welding Safety 06-0100-30/37191(AAD)
3MH70-0715-1049-2	3M™ Speedglas™ Welding Helmet 9100 with Auto Darkening Filter 9100XX, 06-0100-30SW with side windows
3MH70-0716-0628-2	3M™ Speedglas™ Welding Helmet 9100 FX 06-0600-10SW, SideWindows Auto-Darkening Filter 9100V Shade 5, 8-13
3MH70-0716-0630-8	3M™ Speedglas™ Welding Helmet 9100 FX 06-0600-20SW, with SideWindows and Auto-Darkening Filter 9100X Shades 5, 8-13
3MH70-0716-0632-4	3M™ Speedglas™ Welding Helmet 9100 FX 06-0600-30SW, with SideWindows Auto-Darkening Filter 9100XX Shades 5, 8-13
3MH71-0003-1978	3M™ Speedglas™ Quick Release Welding Helmet 9100 QR, with Large Size Auto-Darkening Filter 9100X and Hardhat H-701R, 06-0100-20QR
3MH71-0003-1979	3M™ Speedglas™ Quick Release Welding Helmet 9100 QR, with Large Size Auto-Darkening Filter 9100XX and Hardhat H-701R, 06-0100-30QR

Part #	Description
3MH70-0715-1067-4	3M™ Speedglas™ Auto Darkening Filter 9100V, 06-0000-10, Shades 5, 8-13
3MH70-0715-1068-2	3M™ Speedglas™ Auto Darkening Filter 9100X, Shades 5, 8-13, 06-0000-20
3MH70-0715-1069-0	3M™ Speedglas™ Auto Darkening Filter 9100XX, Shades 5, 8-13, 06-0000-30

Part #	Description
3MH70-0715-1009-6	3M™ Speedglas™ Inside Protection Plate 9100V, 06-0200-10
3MH70-0715-1016-1	3M™ Speedglas™ Inside Protection Plate 9100X, 06-0200-20
3MH70-0715-1017-9	3M™ Speedglas™ Inside Protection Plate 9100XX, 06-0200-30
3MH70-0715-1051-8	3M™ Speedglas™ Outside Protection Plate 9100, 06-0200-51-B, Standard
3MH70-0715-1052-6	3M™ Speedglas™ Outside Protection Plate 9100, Welding Safety 06-0200-52-B, Scratch Resistant

3MH70-0715-6456-4
3M™ Speedglas™ 9100 Hard Hat Adapter, 06-0014-00NR for 3M™ Speedglas™ Welding Helmet 9100

3MH70-0715-6456-4
3M™ Speedglas™ Hard Hat Adapter, Welding Safety, 9100 FX, 06-0614-00NR, for 3M™ Speedglas™ Welding Helmet, 9100 FX

3MH70-0712-7294-5
3M™ Speedglas™ Welding Helmet Battery, 04-0320-00/37137(AAD). Replacement batteries for 3M™ Speedglas™ Filters Utility and 9000 Series. Batteries are type CR2032



3M™ Speedglas™ Welding Helmet 9002NC – reengineered for a better view, and more comfort. A legend reborn. Advanced auto-darkening optics are easily adjusted to meet your working conditions for a lighter, brighter and more detailed view of your welds. And a lighter weight, slim profile means less constriction in tight spaces



Part #	Description
3MH04-0100-20NC-CA	3M™ Speedglas™ Welding Helmet 9002NC with welding filter
3MH04-0000-21NC-CA	3M™ Speedglas™ 9002 NC Welding Filter
3MH04-0112-00NC	3M™ Speedglas™ Welding Helmet 9000 without ADF welding filter

Part #	Description
3MH71-0002-5866	3M™ Adflo™ Powered Air Purifying Respirator High Efficiency System with 3M™ Speedglas™ Welding Helmet 9100-Air, 35-1101-20SW, with Lithium Ion Battery, Side Windows and Auto-Darkening Filter 9100X, Shades 5, 8-13
3MH71-0002-5867	3M™ Adflo™ Powered Air Purifying Respirator High Efficiency System with 3M™ Speedglas™ Welding Helmet 9100-Air, 35-1101-30SW, with Lithium Ion Battery, Side Windows and Auto-Darkening Filter 9100XX, Shades 5, 8-13
3MH71-0002-5868	3M™ Adflo™ Powered Air Purifying Respirator High Efficiency System with 3M™ Speedglas™ Welding Helmet 9100 FX-Air, 36-1101-10SW, with Lithium Ion Battery, Side Windows and Auto-Darkening Filter 9100V, Shades 5, 8-13
3MH71-0002-5869	3M™ Adflo™ Powered Air Purifying Respirator High Efficiency System with 3M™ Speedglas™ Welding Helmet 9100 FX-Air, 36-1101-20SW, with Lithium Ion Battery, Side Windows and Auto-Darkening Filter 9100X, Shades 5, 8-13
3MH71-0002-5870	3M™ Adflo™ Powered Air Purifying Respirator High Efficiency System with 3M™ Speedglas™ Welding Helmet 9100 FX-Air, 36-1101-30SW, with Lithium Ion Battery, Side Windows and Auto-Darkening Filter 9100XX, Shades 5, 8-13
3MH71-0002-5871	3M™ Adflo™ Powered Air Purifying Respirator High Efficiency System with 3M™ Speedglas™ Welding Helmet 9100 MP, 37-1101-10SW, with Lithium Ion Battery, Hard Hat, Side Windows and Auto-Darkening Filter 9100V, Shades 5, 8-13,
3MH71-0002-5872	3M™ Adflo™ Powered Air Purifying Respirator High Efficiency System with 3M™ Speedglas™ Welding Helmet 9100 MP, 37-1101-20SW, with Lithium Ion Battery, Hard Hat, Side Windows and Auto-Darkening Filter 9100X, Shades 5, 8-13
3MH71-0002-5873	3M™ Adflo™ Powered Air Purifying Respirator High Efficiency System with 3M™ Speedglas™ Welding Helmet 9100 MP, 37-1101-30SW, with Lithium Ion Battery, Hard Hat, Side Windows and Auto-Darkening Filter 9100XX, Shades 5, 8-13



Part #	Description
3MH70-0715-4461-6	3M™ Adflo™ Powered Air Purifying Respirator (PAPR) High Efficiency Particulate Filter, Respiratory Protection 15-0299-99X02/37145(AAD)
3MH70-0715-4462-4	3M™ Adflo™ Powered Air Purifying Respirator (PAPR) High Efficiency Particulate Filter, Respiratory Protection 15-0299-99X06
3MH70-0715-4463-2	3M™ Adflo™ Powered Air Purifying Respirator (PAPR) High Efficiency Particulate Filter, Respiratory Protection 15-0299-99X36



3M™ Adflo™ Replacement Cartridges Organic Vapor/Acid Gas(OV/SD/CL/HC)
15-0499-99X02
15-0499-99X06



3M™ Adflo™ Prefilter, Welding Safety
15-0099-99X06/37144(AAD)
15-0099-99X12



3MH71-0002-5244
3M™ Adflo™ PAPR Battery Smart Charger, 35-0099-08, for Lithium Ion Battery



3MH71-0002-5245
3M™ Adflo™ Powered Air Purifying Respiratory (PAPR) Battery, 35-1099-07, Lithium Ion



ANT6105
Single D & E
Cylinder
Cart Heavy-
duty frame



ANT6114
Single
Cylinder
Medical Cart
/ Retractable
Unit Heavy-
duty cart.
Retractable
unit



ANT6120
12-Cylinder Medical Stand, 400 lb Load
Capacity. All-welded steel construction
ensures greater durability, strength and
longer life of the unit. Designed for use
where there is a need for multiple
cylinder storage and mobility is not a
factor. Heavy-duty frame.



ANT94L16
Cylinder Truck with
16 inch Pneumatic
Wheel



ARO1000F-0141
Blue Doom Carrera
shell with 1000FCF
Filter



AROOPT-1000
Black Optiva® Helmet with
Inside Variable Filter



AROS240-9
AROS240-10
AROS240-11
Retro Fit Auto-Darkening
Filter. Shades 9, 10, 11 -
Horizontal 2" X 4 1/4" X .2"



AROX81VX-1500
Black Vision Helmet with
X81VX *New Digital ASIC
A/D lens*



ATL26
Atlas Long-Nek Tomahawks® -
Replacement Handle 13 inch
hickory handle



ATL5
WRENCH
B & MC
Made to fit
your valve
stems and
gas fittings



ATLH
Tomahawk Cone & Chisel
Hammer with Steel Handle
Heads are "pinned" for
safety and reliability.
Manufactured under the
same rigid standards as all
hammers. These popular
models feature "Flex-O"
steel coil hand grips welded
to tough steel handle shafts



ATLJ
Standard Wood
Grip Tomahawk

ATLN
Super Wod Grip
Tomahawk
11" x 7 1/2", 16 oz



ATLAT-HSS
Stainless Steel Tomahawk Coil
Handle- Conforms to weld code
requirements for food processing
equipment, nuclear plants, & other
ind. Fab/welding stainless steel. 10
1/2" x 6 1/2", 15 oz.



ATLHCP
Cone & Cross Chisel
Hammer Tomahawk

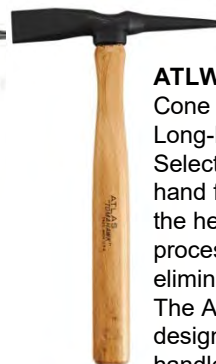

ATLWH-20
Cone & Chisel
Long-Nek Tomahawk
Select Hickory handles are
hand fitted and secured in
the head by our unique
process which virtually
eliminates handle loosening.
The Atlas "Long Nek" head
design offers 50% greater
handle support and
protection from handle
splinter caused by working
over an edge



ATLWH-30
Cone & Cross Chisel
Longneck Tomahawk
Atlas "Long Nek"
head design offers
50% greater handle
support and
protection from
handle splinter
caused by working
over an edge



BER40B
Bernard™ 40B Shortstub™ Stick Electrode Holder. Electrode can be used to within one inch of the high heat. Designed to greater improve productivity with a quick and easy installation of electrodes, eliminating total replacement

BERK40
Head Assembly for use with Shortstub



BWH
H Style Chipping Hammer



OKIWG3 Ground Clamp 300 AMP
OKIWG5 Ground Clamp 500 AMP



Bestweld Cable Connector
BWCCS SET
BWCCM Male
BWCCF Female



Part	Description
BWSSS-G	Cylinder Cart For Side By Side Small
BWSSM-G	Cylinder Cart For Side By Side Medium
BWSSL-G	Cylinder Cart For Side By Side Large
BWSSLP	Cylinder Cart For Side By Side Large Pneumatic
BWBBM-G	Cylinder Cart For Back To Back Medium
VAUSM100	Cylinder Cart For MIG
VAU207G-G	Cylinder Cart Single



Part #	Description
BWS22-023-003X	Carbons 1/8 X 12 DCCC
BWS22-033-003X	Carbons 3/16 X 12 DCCC
BWS22-043-003X	Carbons 1/4 X 12 DCCC
BWS22-053-003X	Carbons 5/16 X 12 DCCC
BWS22-063-003X	Carbons 3/8 X 12 DCCC
BWS22-983-003X	Carbons 5/32 X 12 DCCC



Part	Description
BWS1167GE3	1/16x7 Ground E3 Tungsten 10/Pkg
BWS1167GZ	1/16x7 Ground Zirtung 10/Bx
BWS187G	1/8x7 Ground Pure 10/Bx
BWS187GE3	1/8x7 Ground E3 Tungsten 10/Pkg
BWS187GZ	1/8x7 Ground Zirtung 10/Bx
BWS3327G	3/32x7 Ground Pure 10/Bx
BWS3327GZ	3/32x7 Ground Zirtung 10/Bx
BWS3327GE3	3/32x7 Ground E3 Tungsten 10/Pkg



Part	Description
BWS70S6-0.6-1	ER70S-6 .023 X 2lb Spool
BWS70S6-0.6-5	ER70S-6 .023 X 11lb Spool
BWS70S6-0.8-1	ER70S-6 .030 X 2lb Spool
BWS70S6-0.8-5	ER70S-6 .030 X 11lb Spool
BWS70S6-0.9	Er70S-6 .035 X 15Kg Spool
BWS70S6-0.9-1	Er70S-6 .035 X 2lb Spool
BWS70S6-0.9-5	Er70S-6 .035 X 11lb Spool



BWS-MP8
Bestwelds MIG Economy Plier. Multi-purpose spring-loaded MIG plier designed specifically for CO2 welding operations maintenance and other different tasks



Part	Description
BWS71-030-10	E71T-GS Fluxcor 030 X 10 lb
BWS71-030-2	E71T-GS Fluxcor 030 X 2 lb
BWS71-035-10	E71T-GS Fluxcore 035 x 10 lb
BWS71-035-2	E71T-GS Fluxcor 035 X 2 lb



BWS-YS-50
Bestwelds Welper MIG Gun Plier. Multipurpose tool with 8 functions resulting in more efficient time and production. Durable carbon steel construction paired with an easy to use spring operated handle



Part	Description
BWSRA160TE	Raparound 4X 4 36 Tough Edge
BWSRA170TE	Raparound 4X 6 310 Tough Edge
BWSRA177TE	Raparound 4X 7 412 Tough Edge
BWSRA179TE	Raparound 4X 9 616 Tough Edge



OKIBS400EH
400 Amp Bernard Style
Electrode (Ehbn40)
OKIBWRH
Replacement Head For
400Eh (Ehss40Hd))



OKIWG200 - 300 - 500
Ground Clamp 200 Amp (Ecal20)
300 Amp (Ecal30)
500 Amp (Ecal50)



BWTD-16
Bestwelds Nozzle
Dip



OKINS-16
Flat Soapstone
(288Gr/Skid)
Dimension
3/16" X 1/2" X 5"



OKINS-16A
Soapstone(Round)
(5 X 1/4)

Welding Hose

Part	Description
HOSRH-2102	1/4"X25 Grade R Twin Hose
HOSRH-2103	1/4"X50 Grade R Twin Hose
HOSRH-2105	1/4"X100 Grade R Twin Hose
HOSRH-2107	1/4"X25 Grade R Twin Hose
HOSRH-3127	1/4" Green Grade R Single Hose

Part #	Description
HOSTH-1731	1/4 X 25 BB Hose Grade T Twin Line
HOSTH-1741	1/4 X 50 BB Hose Grade T Twin Line
HOSTH-1751	1/4 X 100 BB Hose Grade T Twin Line
HOSTH-1931	3/8 X 25 BB Hose Grade T Twin Line
HOSTH-1941	3/8 X 50 BB Hose Grade T Twin Line
HOSTH-1951	3/8 X 100 BB Hose Grade T Twin Line



HOSRH-14GH-6
Welding Hose Single
1/4 X 6' Black

HOSRH-14INERT
1/4 Black Inert Hose
750 Ft

Cutting Tips

Part	Description
BWS1-101-0 to 6	1-101-0 to 6 Victor
BWS3-101-0 - 4	3-101-0 to 5 Victor
BWS4202-2 to 9	4202-2 to 9 Purox
BWS6290-0 to 5	6290-0 to 5 Harris



Part #	Description
900-17FV	Bestwelds Torch Body Flexible with Valve
900-17FV-25-R	Bestwelds Torch Package X 25ft Rubber
900-18-25-R	Bestwelds Torch Package X 25ft
900-20-25-R	Bestwelds Torch Package 25 Ft Braided



Part	Description
900-10N23	Bestwelds Standard Collet 1/16 1.6mm 5 Pack
900-10N24	Bestwelds Standard Collet 3/32 2.4mm 5 Pack
900-10N25	Bestwelds Standard Collet 1/8 3.2mm 5 Pack
900-10N28	Bestwelds Collet Body 1/82 3.2mm 5 Pack
900-10N31	Bestwelds Collet Body 1/16 1.6mm 5 Pack
900-10N32	Bestwelds Collet Body 3/32 2.4mm 5 Pack
900-10N46	Bestwelds Ceramic Cup 1/22 13mm 10 Pack
900-10N47	Bestwelds Ceramic Cup 7/16 11mm 10 Pack
900-10N48	Bestwelds Ceramic Cup 3/8 10mm 10 Pack
900-10N49	Bestwelds Ceramic Cup 5/16 8mm 10 Pack
900-10N50	Bestwelds Ceramic Cup 1/4 6mm 10 Pack



900-4E315M
Bestwelds Bernard
Style Mig Gun 300A
15FT Cable Miller End



900-4E315T
Bestwelds Bernard
Style Mig Gun 300A
15FT Cable Tweco End

Nozzles



Part	Description
900-4391	Bestwelds Bernard Style Nozzle 5/8/16mm 5 Pack
900-4392	Bestwelds Bernard Style Nozzle 1/2/13mm 5/ Pack
900-4393	Bestwelds Bernard Style Copper Nozzle 5/8/16mm 5 Pack

Contact Tips



Part	Description
900-7488	Bestwelds Bernard Style Contact Tip .030/0.8mm ECU
900-7489	Bestwelds Bernard Style Contact Tip 0.35/0.9mm ECU
900-7490	Bestwelds Bernard Style Contact Tip .045/1.2mm ECU
900-7491	Bestwelds Bernard Style Contact Tip 1/161.6mm ECU

Liner



900-43115
Bestwelds
Bernard Style
Steel Liner X
15ft 0.8-1.2

Head Assembly

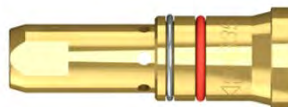

900-4335
Bestwelds Bernard
Style Head Assembly
5 Pack

Nozzles

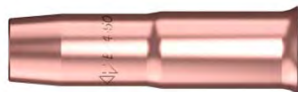

Part	Description
900-24A-50	Bestwelds Tweco Style Nozzle Adjustable 1/2/13mm 5 Pack
900-24A-62	Bestwelds Tweco Style Nozzle Adjustable 5/8/16mm 5 Pack
900-24A-75	Bestwelds Tweco Style Nozzle Adjustable 3/4/19mm 5 Pack
900-24CT-50S	Bestwelds Tweco Style Fixed Nozzle Coarse 1/2/13mm 5 Pack
900-24CT-62S	Bestwelds Tweco Style Fixed Nozzle Coarse 5/8/16mm 5 Pack
900-24CT-75S	Bestwelds Tweco Style Fixed Nozzle Coarse 3/4/19mm 5 Pack
900-34A	BWS Tweco Style Adjustable Nozzle Insulator 5/pack
900-34CT	BWS Tweco Style Nozzle Insulator Coarse Thread 5/pack

Diffusers



Part	Description
900-0051	BWS Tweco Style Gas Diffuser M6 5/pack
900-0052	BWS Tweco Style Gas Diffuser ¼ UNF 5/pack
900-054A	BWS Tweco Style Gas Diffuser ¼ UNF 5/pack

Contact Tips



Part	Description
900-14-35	Bestwelds Tweco Style Contact Tip .035/0.9mm ECU 25 Pack
900-14-45	Bestwelds Tweco Style Contact Tip .045/1.2mm ECU 25 Pack
900-14-116	Bestwelds Tweco Style Contact Tip 1/16/1.6mm ECU 25 Pack
900-14H-35	Bestwelds Tweco Style Contact Tip .035/0.9mm ECU HD 25 Pack
900-14H-45	Bestwelds Tweco Style Contact Tip .055/0.1.2mm ECU HD 25 Pack
900-14H-116	Bestwelds Tweco Style Contact Tip 1.6mm ECU HD 25 Pack

Liners



Part	Description
900-44-3545-15	Bestwelds Tweco Style Liner Conduit 0.9-1.2mm X 15ft
900-44-116-15	Bestwelds Tweco Style Liner Conduit 1.6mm X 15ft



GLASS FILTER PLATE

Best Welds filter plates offer ultimate protection against ultraviolet and infrared rays present in the welding environment. Precisely shaded and optically correct.. Precision ground and edged to allow a safe and proper fit

Bestwelds-2X4-1/4



Part	Shade
CEP932-105-8	Shade 8
CEP932-105-9	Shade 9
CEP932-105-10	Shade 10
CEP932-105-11	Shade 11
CEP932-105-12	Shade 12



Bestwelds Hardened Glass Filter Plate -4-1/2X5-1/4

Part	Shade
CEP932-107-8	Shade 8
CEP932-107-9	Shade 9
CEP932-107-10	Shade 10
CEP932-107-11	Shade 11
CEP932-107-12	Shade 12

Polycarbonate Filter Plate 4.5X5.25



Part	Shade
CEP932-108-8	Shade 8
CEP932-108-9	Shade 9
CEP932-108-10	Shade 10
CEP932-109-11	Shade 11
CEP932-108-12	Shade 12

Bestwelds 2x4-1/4 Gold Coated Poly Filter Plate



Part	Shade
CEP932-109-8	Shade 8
CEP932-109-9	Shade 9
CEP932-109-10	Shade 10
CEP932-109-11	Shade 11
CEP932-109-12	Shade 12



Part	Description
CEP932-145-100	Glass Magnifier 2x4.25 1.0 Diopter
CEP932-145-125	Glass Magnifier 2x4.25 1.25 Diopter
CEP932-145-150	Glass Magnifier 2x4.25 1.50 Diopter
CEP932-145-175	Glass Magnifier 2x4.25 1.75 Diopter
CEP932-145-200	Glass Magnifier 2x4.25 2.0 Diopter
CEP932-145-250	Glass Magnifier 2x4.25 2.5 Diopter
CEP932-145-300	Glass Magnifier 2x4.25 3.0 Diopter



Part	Description
CEP932-146-100	Magnifier Plate Plastic 2X4.25 1.0 Diopter
CEP932-146-125	Magnifier Plate Plastic 2X4.25 1.25 Diopter
CEP932-146-150	Magnifier Plate Plastic 2X4.25 1.50 Diopter
CEP932-146-175	Magnifier Plate Plastic 2X4.25 1.75 Diopter
CEP932-146-200	Magnifier Plate Plastic 2X4.25 2.0 Diopter
CEP932-146-225	Magnifier Plate Plastic 2X4.25 2.25 Diopter
CEP932-146-250	Magnifier Plate Plastic 2X4.25 1.0 Diopter



901-WG-50C
Best Welds Cup Goggles. Baffled side-shields allow maximum ventilation while preventing entry of light. Adjustable elastic headband and nose piece for comfort Lightweight and durable Shade 5



CEP932-4199UCL
Face Shield Visor PETG Clear 9.75x19 Pliable, yet durable Protects face and eyes from airborne debris. Universal holes fit most manufacturers' face shields



CEP932-4199UCL
Face Shield Visor PETG Dark Green 9.75x19 Pliable, yet durable. Protects face and eyes from airborne debris. Universal holes fit most manufacturers' face shields



901-WG-2414RFF
Best Welds Goggle Fixed Front Rigid 2X4-1/4 Shade 5. Contoured shape fits snugly for comfort. Fits over RX glasses. Parts easily removable for replacement



CEP932-442
Safety Plate Poly 4-1/2 X 5-1/4 Light-weight. Optically correct and balanced. Strong impact resistance for safety



CEP932-440
Safety Plate Polycarbonate Safety Plate 2 X 4 Light-weight. Optically correct and balanced. Strong impact resistance for safety



CEP932-740
CR39 Clear Plastic Cover Lens 2X4.25



CEP932-742
CR39 Clear Plastic Cover Lens 2X4.25



CAI1452
Extra-Wide Reinforced Palm. Premium Cow Split Leather. Extra wide palm reinforcement for max wear & protection. Reinforced wing thumb Aerofoam™ lining; full sock construction for unmatched comfort & insulation 100% Kevlar™ thread for maximum seam strength



CAI1810
Revolution MIG / Multi-Task, Cow Grain Unlined, padded and reinforced palm for added protection and comfort. Top grain leather forchettes and fingertips. Two-layer insulated back for protection from radiant heat

1812



CAI1812
Revolution Welding Gloves, Tan/Gold, 4" Gauntlet, Pig Grain Leather Complimentary 3 in carabiner to keep gloves together with loops on each pair. Exclusive Kontour™, Design--Sewn with 100% Kevlar™ thread



CAI1816
Stick / MIG, Deerskin, Green Super supple deer suede palm with double stitched padding and wear-patch. Large pulse protector Full sock-insulation with FR (flame resistant) foam/fleece. Sewn with Kevlar® thread

1828



CAI1828
Revolution Multi-Task, Cow Grain Unlined, padded and reinforced palm and thumb saddle for added protection and comfort

1864



CAI1864
Caiman Deerskin Glove. Excellent all-around glove for TIG welding, gas welding and plasma cutting

1868



CAI1868
Caiman® Revolution® Welding Gloves for Multi-Task/TIG Welding, Goat-Grain Leather, White/Gold. 3-dimensional patterns, pre-curved fingers and form-fitting for ultimate fit, comfort and dexterity. Patches, padding and reinforcements for comfort and protection. Sewn with 100% Kevlar thread



CAI1878
21" Deerskin Welders Industry First! - 21" glove with heavy duty padding on the forearm and elbow for comfort. Boarhide™ leather heat shield patch, reinforced palm, cuff and lean-on patch

2950



CAI2950
Multi-Activity Glove Large Rhino-Tex™ synthetic leather palm

2955



CAI2955
White Goat Grain Multi-Activity MAG Gloves feature internal padded palm, Air-Mesh ultra-breathable back, Pinched-Tip fingers

2970



CAI2970
Gray Deerskin Multi-Activity MAG Gloves feature internal padded palm, Air-Mesh ultra-breathable back and Pinched-Tip fingers

2981



CAI2980
White Goat Grain Hi-Vis Lime Reflective Multi-Activity MAG Gloves features internal padded palm, Air-Mesh ultra-breathable back, Pinched-Tip fingers

3030



CAI3030
Gold Boarhide 30 Coat / Jacket features satin lined shoulders/sleeves, corduroy collar, inside pocket, reinforced stress points & 100% Kevlar

3031



CAI3031
Boarhide Cape Sleeves feature corduroy lined collar, reinforced stress points & sewn with 100% Kevlar with folded, double stitched construction

3136



CAI3136
Boarhide Bib Apron is available in 36in, 42in & 48in lengths. Offers superior cut, abrasion and heat resistance than cowhide



CAI3142
Boarhide Bib Apron is available in 36in, 42in & 48in lengths. Superior cut, abrasion and heat resistance versus cowhide



CAN300-230
CAN300-4L
CAN300-DR
 Leak Detection Compound - Oxygen Compatible - Approved For Oxygen Use – Regular Temp Type I - 8 oz or 4 Liters



CAN365-230
CAN365-4L
 Leak Detection Compound - Oxygen Compatible - Approved For Oxygen Use - Low Temp Type II-8oz or 4 Liters



CANAG-16-A
 Bright Zinc Galvanizing Spray. Provides a brilliant metallic aluminum finish. Provides superior zinc protection on welds, galvanized steel, base iron and other ferrous surfaces exposed to harsh and corrosive environments



CANAS-16-A
CANAS-1G
CANAS-20L
 Heavy duty anti-spatter is a non-flammable, quick drying, solvent based spray. Heat resistant for high temperature applications



CANCE101-A
 Cleaner - Standard.NDT STD Cleaner Aerosol. Blend of petroleum hydrocarbon solvents. Cleaner. Meets ASME section V halogen and chloride content requirements



CANCF1-4L
CANCF1-5G
CANCF1-DR
 Cooling Fluids - water and ethylene glycol based formulation which is designed to cool and protect equipment. Temperature Range: +19°F / -7°C



CANCF2-4L
CANCF2-5G
CANCF2-DR
 Cooling Fluids a water and ethylene glycol based formulation which is designed to cool and protect equipment. Designed for use in Plasma, MIG, TIG and resistance welding systems. Temperature Range: +6°F / -14°C



CANCF3-4L
CANCF3-5G
CANCF3-DR
 Cooling Fluid. Designed for use in Plasma, MIG, TIG and resistance welding systems. A Water and ethylene glycol based formulation which is designed to cool and protect equipment. Low temperature cooling fluid formulation. Temperature Range: -32°F / -35°C



CAND101-A
 Dye Penetrant Inspection Developer D101 is a non-aqueous wet developer that sprays out white for red dye

CANLUBE-4 -CANLUBE-6 - CANLUBE-25
 Wire Lube Pads. Regular Pre-treated replacement pads that reduce friction in wire feed units. Pads are coated to remain wet without containing excess liquid material. Product is non-irritating, non-toxic, odorless. Does not contain silicones or chlorinated solvents



CANES-16-A
 Premium Anti-spatter Water Based Concentrate 16oz. Premium quality water based anti-spatter compound that provides a thin, uniform protective coating on MIG nozzles, tips, fixtures and materials during weld process. Prevents spatter build up in welding applications on all types of materials including steel, stainless steel, aluminium



CANP101S-A
 Penetrant Solvent. Red dye, solvent removable penetrant indicates surface flaws against white developer powder background. No chlorinated solvents, meets ASME section V halogen and chloride content requirements
CANP301W-A
 Penetrant Water Penetrant Solvent. Red dye, water removable penetrant indicates surface flaws against white developer powder background



CANTD-16
 Premium Nozzle Tip Dip made from USP grade materials and provides a rich protective barrier which prevents spatter build up on MIG gun nozzles, tips, positioners and fixtures



CENTURY®

Part #	Length Ft.	AWG Size	Amps	Color
CWCD13308025	25	8	40	Black
CWCD13308050	50	8	40	Black



COMEAX CAPS®

Deep Round Crown Cap Assorted Single sided. Super soft brim fitted welders cap

Part	Size
CMX1000E	One Size Fits All
CMX2000R-712	7 1/2
CMX2000R-714	7 1/4
CMX2000R-718	7 1/8
CMX2000R-734	7 3/4
CMX2000R-738	7 3/8
CMX2000R-758	7 5/8



CONTOUR®



Jackson Safety Contour WRAP-A-ROUND*. An inexpensive tool for marking straight lines around pipe. Made out of flexible gasket material, with good resistance to heat and cold

Part	Size
KCP14752	3001858 Contour #164B WRAP-A-ROUND* Black Med
KCP14753	3001859 Contour #176B WRAP-A-ROUND* Black Large
KCP14754	3001860 Contour #177B WRAP-A-ROUND* Black X-Large 7'
KCP14756	3001861 Contour #179B WRAP-A-ROUND* Black X-Large 9'
KCP14766	3001869 Contour #177GG WRAP-A-ROUND* Grey Large 7'



KCP14771
Contour #1 Marker
The Contour Marker consists of an X frame, calibrated protractor, and a triple-jointed marking arm adjustable to the line to be scribed



KCP14775 Standard
KCP14776 Jumbo Spring Loaded
Contour Centering Heads aid in the settings of centerlines, establishing angles and marks for butt-ins, locating points inside pipes and tanks, laying out keyways and measuring declivity

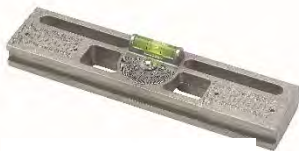

KCP14777
8" Pro Mag Level 2 cast-in 25-pound pull magnets. 360-degree adjustable DSL with two 90-degree quadrants graduated in 2-1/2 degree increments. Groove on bottom permits use on small pipe. Lightweight



KCP14780 - KCP14781 - KCP14782
Radius Marker All are a folding type design, the three smaller models will fit conveniently into a shirt pocket. All have sturdy friction joints to maintain rigidity and accuracy. Precision tools made of rust proof aluminum and anodized for lasting protection. The arms are precisely aligned with spring tension joints to guarantee accuracy and rigidity. The holder accommodates flat or round soapstone and pencils



KCP14785
#19 For reliable marking using standard 1/2 inch pipe, Multi-Trammel Heads feature radius set points cast in alignment with marking pointers for easy setting.



KCP14791
Contour #28 Magnetic Burning Guide The CURV-O-MARK* Pro-Mag Burning Square is a precise tool used in structural thermal cutting and layout



KCP14795
Jackson Safety* Contour #32 Pipe Flange Aligner. Remove the difficulty of flange aligning and squaring with a sample tool that holds a square in the needed position without tying up one's hands.



KCP14797
Contour Dial-Set-Level (DSL) Replacement Dial & Level Adjustable bubble protractor. Bubble cast in aluminum dial. Covers 180 degrees through two 90 degree quadrants



EAG42
 Plug For 1252 EQ To Lev 93
 Connecting and protecting electrical loads is crucial to reliable, efficient and safe power management with a facility. Constructed of unbreakable thermoplastic



EAG1252
 Receptacle EQ To Lev 5378
 Connecting and protecting electrical loads is crucial to reliable, efficient and safe power management with a facility. Constructed of unbreakable thermoplastic

Cylinders



Part	Description
CYL20CF-540	20 cu. Ft. Steel Cylinder with CGA 540
CYL20CF-580	20 cu. Ft. Steel Cylinder with CGA 580
CYL40CF-540	40 cu. Ft. Steel Cylinder with CGA 540
CYL40CF-580	40 cu. Ft. Steel Cylinder with CGA 580
CYL55CF-540	55 cu. Ft. Steel Cylinder with CGA 540
CYL55CF-580	55 cu. Ft. Steel Cylinder with CGA 580
CYL80CF-540	80 cu. Ft. Steel Cylinder with CGA 540
CYL80CF-580	80 cu. Ft. Steel Cylinder with CGA 580
CYL125CF-540	125 cu. Ft. Steel Cylinder with CGA 540
CYL125CF-580	125 cu. Ft. Steel Cylinder with CGA 580
CYL150CF-540	150 cu. Ft. Steel Cylinder with CGA 540
CYL150CF-580	150 cu. Ft. Steel Cylinder with CGA 580
CYL220CF-540	220 cu. Ft. Steel Cylinder with CGA 540
CYL220CF-580	220 cu. Ft. Steel Cylinder with CGA 580
CYL250CF-540	250 cu. Ft. Steel Cylinder with CGA 540
CYL250CF-580	250 cu. Ft. Steel Cylinder with CGA 580
CYL300CF-540	300 cu. Ft. Steel Cylinder with CGA 540
CYL300CF-580	300 cu. Ft. Steel Cylinder with CGA 580
CYLB-ACET	B Acetylene 40 cu. Ft.
CYLMC-ACET	Mc Acetylene 10 cu. Ft.
CYL75-ACET	75 cu. Ft. Acetylene
CYL145-ACET	145 cu. Ft. Acetylene
CYLC5-320	5lb Co2 Cylinder
CYLC10H-320	10lb CO Cylinder with Handle
CYLC20H-320	20lb Co2 Aluminum Cylinder with Handle
CYLN-60	55.1 CF Aluminum Cylinder with Valve And Handle
CYLN-90	80 CF Aluminum Cylinder with Valve And Handle



by Honeywell



FM110PWECSA
Pipeliner with Fiberglass, White, 2X4 Shade 10, Rubber Headband Comfortable, functional headgear. Compact design allows access to areas where there is no room for a standard helmet



FM1CP
Custom-fit Replacement Headgear with Neoprene headgear strap. Exclusive free-floating arms balance and stabilize the helmet while minimizing pressure points. Overhead band with multiple adjustments. Strip-proof ratchet head size adjustment provides small increment sizing



FM2006SRCSA
Futura Thermoplastic Welding Helmet Shade10



FMH106A
Economy welding helmet. Lift front with P-247 polycarbonate shade 10 filter plate and PC-242 poly clear cover plate, FM106HG headgear



FMSE2QC02A000
Cap Style Hard Hat, Sensor Multi-Directional Protective Cap, Quick-loks. Provides a dual impact energy control system that senses the point of impact and activates the appropriate force attenuation system. A blow to the crown activates the SuperEight™ crown impact system



FM3C
Custom-fit Replacement Headgear with Standard Headgear Deeply offset, pliable headband fits head contours comfortably. Exclusive free-floating arms balance and stabilize the helmet while minimizing pressure points. Strip-proof ratchet head size adjustment provides small increment sizing



FM3RW2
Suspensions with ratchet for E1, E2 Fibre-Metal™. The 360 ° degree padded sweatband provides extra comfort for all day wear. The patented SwingStrap™, combines the benefits of both the ratchet and the 360 padded sweatband with the added ability to convert from forward to reverse wearing position without having to remove and reinstall the suspension.



FMFM4001
Quik-Lok Welding Helmet Parts & Accessories Kit



FM4000
Welding Helmet Protective Cap Components with Quik-Lok™, Complete Kit Fully adjustable to better fit Fibre-Metal caps and major competitive brands. Model 4000 Quik-Lok provides more permanent mounting for longer term or high activity applications.



FM4118CL
.060" 8"X11-1/4" Clear View Faceshield Preformed to the curve of the crown. SEI certified to comply with current ANSI standards



FM4118DGN
.060" 8"X11-1/4" Dark Green Standard View Faceshield Preformed to the curve of the crown. SEI certified to comply with current ANSI



FMF5500
High Performance Faceshield Less Window W/Sp includes crown plus hard hat attachment. 1/4" steel base and support post adds rigidity reducing vibration



FMF4400
Head Gear with F4400 High Performance faceshields are stronger, more durable and more heat resistant than ordinary faceshields. Made from Noryl™ the same material used in our welding helmets



FMF5400
High Performance Faceshield Headgear for use with Protective Caps, F400 4". Crown with Adjustable 5000 Speedy Loop, Attach to Cap series Hard Hats.



by Honeywell



FM4178CL
Faceshield Window Wide Vision Size, .060" 8" X 16 1/2" Clear, Injection Molded, Fits F400, F500 Series, FH66, FM70, FM71.

FM4178IRUV5
High Performance Faceshield Window Wide View Preformed to the curve of the crown. SEI certified to comply with current ANSI standards

FM4178IRUV8
Faceshield Window Wide Vision, .060 8"X16 1/2" IR/UV Shade 8, Injection Molded, Fits F400, F500, FH66, FM70, FM71. Use for Plasma Cutting

FM4178DGN
Faceshield Window Wide Vision Size, .060" 8" X 16 1/2" Dark Green, Injection Molded, Fits F400, F500 Series, FH66, FM70, FM71.



FM4199CL
Faceshield Window Extended View .060" 9 3/4" X 19" Clear, Injection Molded, Fits F400 and F500 Series and FH66.

FM4199IRUV5
Faceshield Window Extended View .060" 9 3/4" X 19" IR/UV Shade 5, Injection Molded, Fits F400 and F500 Series and FH66

FM4199DGN
Faceshield Window Extended View .060" 9 3/4" X 19" Dark Green, Injection Molded, Fits F400 and F500 Series and FH66.

FM4906BECSA
FM4906GYCSA Grey Tigerhood Classic Welding Helmet, Colors, Thermoplastic, Lift Front, 4001 Mounting Cups



FM4990GY-CSA
Welding Helmet Shell Gray W/4001 Mounting Cup Available in a variety of colors. Molded-in colors eliminate chipping, peeling, fading. Smooth, seamless shell deflects sparks and spatter reducing the risk of burn through. Unique welding helmet design provides extended throat protection while blocking fumes and smoke from the face



FM5000
Welding Helmet Protective Cap Components with Speedy-Loop™. Fully adjustable to better fit Fibre-Metal caps and major competitive brands. Model 5000 Speedy-Loop provides easy on/off welding helmet mounting on protective caps.



FM5906GY-CSA
Welding Helmet Shell Gray with 5000 Mounting Loop Available in a variety of colors. Molded-in colors eliminate chipping, peeling, fading. Smooth, seamless shell deflects sparks and spatter reducing the risk of burn through. Unique welding helmet design provides extended throat protection while blocking fumes and smoke from the face



FM6000
Slotted Cap Blades. Fully adjustable to better fit Fibre-Metal caps and major competitive brands. Model 6000 Quick-Lok mounting blades for quick and easy mounting of Fibre-Metal welding helmets



by Honeywell



FM906BECSA BLUE
FM906GYCSA GREY
Helmet 906 SH10. Available in a variety of colors. Molded-in colors eliminate chipping, peeling, fading. Smooth, seamless shell deflects sparks and spatter reducing the risk of burn through. Unique welding helmet design provides extended throat protection while blocking fumes and smoke from the face



FM990GYCSA
Tigerhood Classic Welding Helmet, Gray, 4 1/2" x 5 1/4" Fixed-Front, #10. Wide Vision Molded-in colors eliminate chipping, peeling, and fading. Smooth, seamless shell deflects sparks and spatter reducing the risk of burn through. Unique welding helmet design provides extended throat protection while blocking fumes and smoke from the face



FM998
Thermoplastic Helmet Style Handshield, Wide Vision, Handle Grip



FME2QRW01A000 White
FME2QRW09A000 Grey
FME2QRW71A000 Blue
Cap Style Hard Hat With 3RW2 Ratchet Headband, 8 Pt. Suspension, Quick Lok Blocks, Superlectric Thermoplastic, Class G, C, Type 1. The exclusive smooth crown design contains a technically advanced suspension with eight load bearing points to stabilize and balance the hat or cap during everyday wear



FMF300CSA
High Performance Faceshield Headgear, 3" Crown, Ratchet, Fits Over Protective Spectacles, does not include faceshield. Made from Noryl™ the same material used in our welding helmets



FMF400CSA
High Performance Faceshield Headgear, with deeper 4" Crown, Ratchet Fits Over Protective Spectacles, does not include faceshield. Made from Noryl™ the same material used in our welding helmets



FMF4500
High Performance Faceshield Headgear for use with Protective Caps, F500 7" Crown with Quick-Lok 4001 Mounting Cups, Attach to E2Q or P2NQ/P2HNQ Series Hard Hats



FMF500CSA
High Performance Faceshield Headgear, with deeper 7" Crown, Ratchet, Broader. Fits over Protective Spectacles, does not include faceshield. Made from Noryl™ the same material used in our welding helmets



FMP2AQRW71A000
Cap Style Hard Hat, Roughneck, Fiberglass, Factory Assembled with Quick-Lok blocks and 3R Ratchet Headband, 8 Pt. Ratchet Suspension, Type 1, Class G & C



Part	Colour
FMP2HNQRW01A000	White
FMP2HNQRW03A000	Orange
FMP2HNQRW09A000	Grey
FMP2HNQRW15A000	Red
FMP2HNQRW71A000	Blue

Cap Style Hard Hat, High Heat (up to 500°F/260°C) Superglas Fiberglass Roughneck, Quick-Lok blocks and 3RW3 Ratchet Headband, 8 Pt. Suspension, Type 1 Class G



FMWFG
Weld Fillet Gage. Blades pivot for easy measuring of eleven most specific fillet dimensions. Measures concave or convex seams. Stainless steel blades, etched increments. 1/8" thru 1" Fits in 4 1/2" x 2" case. Carry in pocket.



FLA28439

The Magnetic Circle Layout & Burning Guide is a circle layout tool with sliding soapstone holder and 360° scale on the magnetic base. It will cut circles up to 30" in diameter.



FLA38240T

2 pc. Set flange aligner threaded pins comes with 360° vials that just "snap" in and out for easy replacement. All models of the pipe aligner will two-hole (make 2 holes of the flange horizontally level with the ground) and vertically level the face of the flange in one step. Features slotted pins with "friction fitting" knurled nuts for flanges to 30" - 150 lb-



FLA38240-MAK

Magnetic Flange Aligner Kit. The new ON/OFF magnet allows for a stronger holding power and easy removal of debris. The New Aligner comes in a compact case that will protect the tool from damage and keep it together in one place ready to use



FLA42050T

Two Hole Pins, Alloy Steel, Mini, 1 7/16 in Hole Diameter
Lightweight. Machined from hardened steel for durability and longevity. Utilize fast double lead threads instead of ACME threads for a more reliable hold over time



FLA42050TL

2 Piece Set Two Hole Threaded Pins Large, Alloy Steel, Fits flanges with holes 1/2" to 1-15/16" in diameter. Lightweight. Machined from hardened steel for durability and longevity. Utilize fast double lead threads instead of ACME threads for a more reliable hold over time

FLA53025

Magnetic small centering head is designed for the person who works with smaller diameter pipe (for pipes 1" and larger). Fire protection, fence and gate builders, live stock pens and corrals, and various alignment jobs in the automotive field are a few of the many uses



FLA53076

Magnetic Medium Centering Head (for pipes 6" and larger) is designed to establish and mark a center-line at any angle around the circumference (inside and out) on a pipe or tank. This tool is a must for the welder's or fitters' toolbox



FLA72800 Small
FLA72805 Medium

Radius Marker folding type design, the three smaller models will fit conveniently into a shirt pocket. All have sturdy friction joints to maintain rigidity and accuracy. Precision tools made of rust proof aluminum and anodized for lasting protection. The arms are precisely aligned with spring tension joints to guarantee accuracy and rigidity. The holder accommodates flat or round soapstone and pencils



FLAWW-19

Wizard Wrap Extra Large 12" To 48" Pipe
• 36" tape measure printed on the medium & large Wizard-limits the need for an extra tape measure
• Circumference & Quartering scale printed on every wrap-limits the need for calculation
• Packaged in a durable, reusable container that will hold up in your tool box
• Wizard wrap, made from a non-asbestos, heat resistant material, has a nice thick edge for easier more accurate marking and helps keep your soapstone from slipping



FLAPP-200

Pocket Pro Level 2.5 Increments. Extra strong magnets hold it firmly to any steel surface. Magnetic. There are two (2) stationery vials placed at 90° angles of each other and can be read from any surface of the level. With protractor degree dial



FLASL-100

Standard Pocket Level Magnetic level has three-position leveling that can be viewed clearly from almost any angle. Tradesman who does not need the protractor degree dial



FLAPG-601-1.007

Plasma Cutting Guide With 1.007 Bushing Chamfer edges
• Cuts holes
• Has wheels for stability
• Straight cuts

SHURLITE Made in U.S.A.

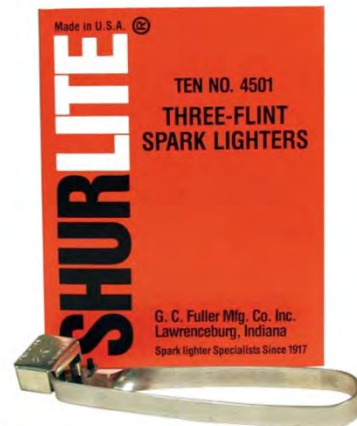

Part #	Description
FUL3001	Single Flint Lighter 10/Box
FUL3001X	Flint Renewals 200 Flints/Box
FUL4501	Three Flint Lighter 10/Box
FUL5012X	Three Flint Renewals 4 / Card
FUL710	One Shootalite Lighter/Card

CABLE



Part #	Description
GEN6-152	Welding Cable 6 X 152 Meter
GEN4-76	Welding Cable 4 X 76 Meter
GEN4-152	Welding Cable 4 X 152 Meter
GEN2-76	Welding Cable 2 X 76 Meter
GEN2-152	Welding Cable 2 X 152 Meter
GEN1-76	Welding Cable 1 X 76 Meter
GEN1-152	Welding Cable 1 X 152 Meter
GEN1/0-76	Welding Cable 1/0 X 76 Meter
GEN1/0-152	Welding Cable 1/0 X 152 Meter
GEN2/0-76	Welding Cable 2/0 X 76 Meter
GEN2/0-152	Welding Cable 2/0 X 152 Meter
GEN3/0-76	Welding Cable 3/0 X 76 Meter
GEN3/0-152	Welding Cable 3/0 X 152 Meter
GEN4/0-76	Welding Cable 4/0 X 76 Meter
GEN4/0-152	Welding Cable 4/0 X 152 Meter



GSEAP-54
Torch Handle propane, front valve for screw-in tips. Keep your tips burning. Very durable handles



GSEHT-100L
Hand Torch- Piezo Lighter Tip Adjustable brass regulator. Cylinder (Not Included). Filtered orifice to prevent clogging. Tip swivels 360°
• Very hot turbine flame



GSEBA-3 TIP Med Solders 3/4
GSEBA-4 TIP Large Solders 1
GSEBA-5 TIP X-Large Solders 1-1/2
Tips have a removable filter and orifice



GSEP-70G
Regulator LP CGA-510 With Gauge- B Hose. All brass regulators used with propane torches and furnaces



GSEHEF-12
Vapour Propane Gas Hose 12ft



GSEKA-1H
Goss KA-1H Kit Adjustable feather flame tips. Economical soldering kit. Kits matched to different tip & tank sizes. Screw-in design handle and tips



GSEMA-80-16
Replacement Gauge for Propane Gas. 1 1/2 in diam. Contents 0-Full



HABRGT61
Stay Safe Bridgit-1/8 X 1# Spool Bridgit® caps like no other lead-free solder and allows its operator to fill both tight and loose, non-concentric connections with ease. Nickel-bearing Bridgit® is the strongest lead-free solder developed for use on potable water systems



HASCPPF1
Stay Clean Paste Flux-1# Jar
HASCPPF4
Stay Clean Paste Flux-4Oz Jar

Common Lead-bearing Solder
With some exceptions, these tin-lead solders can be used to join copper and most copper alloys, lead, nickel alloys and steel. Tin-lead solders are not recommended for joints subject to high stress or vibration in the cooling industry due to lack of sufficient elongation properties. These solders are also available with rosin or acid core.

Part #	Description
HA505061	50/50 Solder 1/8 -1# Solder
HA50A61	50/50 Acid Core-1/8 - 1# Spool
HA50R31	50/50 Rosin Core-1/16 - 1# Spool
HA50R61	50/50 Rosin Core-1/8 X 1# Spool
HA60R11	60/40 Rosin Core-1/32 X 1# Spool
HA60R31	60/40 Rosin Core-1/16 X 1# Spool
HA60R61	60/40 Rosin Core-1/8 X 1# Spool
HA95561	95/5 Solder 1/8 -1# Spool
HA40R61	40/60 Rosin Core-1/8 X 1# Spool



HAC3200301
8700-2500-580 Regulator
Ultra High Delivery Pressure
Regulator. Ergonomic adjusting
knob that also shields the
adjusting mechanism from
contaminants. Large, easy-to-
read gauges



HAC4403224
Steelworker® Classic Tool Bag Kit
Single-stage Oxygen Regulator,
Single-stage Fuel Regulator,
Goggles, Striker, 20' x 3/16" Hose
& Tool Bag. Ideal for brazing,
cutting, heating, soldering and
welding

Machine Cutting Tip



	Model #	Tip Seat Style	Cutting Torch
HAC1502126	Model 6290-1 VVCU	6290	98-6, 98-3
HAC1502128	Model 6290-2 VVCU	6290	98-6, 98-3
HAC1502130	Model 6290-3 VVCU	6290	98-6, 98-3



Pipe Beveling Machine Company, Inc.

HMPHM01
Pipe Bevel Machine
Model1 3-8

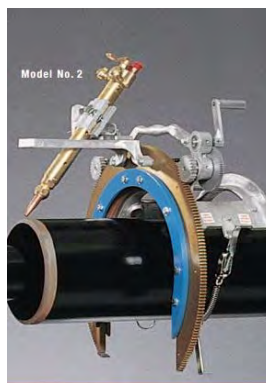

HMPHM02
Pipe Bevel
Machine Model 2
6-12



HMQAFP
Flange Pin
Quick Acting
Set

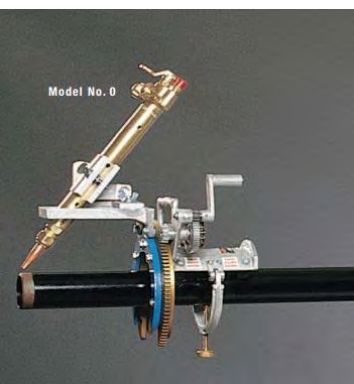

HMPHM00
Pipe Bevel Machine
Model 0 2-4

KCP14381
Jackson Safety* Headgear HDG10 K-
Facesaver Model K Ratchet headgear
with spark deflector secures 12" or
15.5" face shields. Sort, absorbent
wrap-around foam cushioned
sweatband gently hugs at the natural
shape of the head



KCP14391
Model P
Brimmaster
(Cap Coil Spring
Attachment): Model P
Bracket Polyethylene spark
deflector. For attaching any
visor spark deflector
combination, to any non-
slotted cap. Visor Sold
Separately



KCP14531
WH20 860P Leather
Welding Helmet,
Green; #10, Red,
860P, 2 in x 4 1/4 in.
Features a tough
yet pliable leather
covering. Ideal for
use in overhead
welding applications
or when working in
tight spaces



KCP14732
Welding Ground Clamp GC-5. Forged
copper alloy ground clamps have higher
conductivity, fewer residents, and run at
a cooler temperature for better arc
starting. The extra-large contact areas
provide superior conductivity and higher
clamping pressure. Easy jaw opening



KCP14733 Set KCP14737 Female KCP14739 Male
Jackson Safety* Welding QUICK-TRIK* QNB-2-BP
Single Dome Nose QUIK-TRIK top-of-the-line
cable connector halves have morse-tapered
sections that are drawn together with a cam



KCP14940
170-SB Headgear. HDG20 Face Shield Headgear 170-SB Fully dielectric. Meets ANSI Z87.1 2010 Standards when used with any JACKSON SAFETY* Brand Headgear



KCP14948
137 Cap Shield. Cap Coil Spring Attachments Curved aluminum channel and coil spring attachment. For attaching any visor spark deflector combination, to any non-slotted cap. Metal device for non-slotted caps. Polyethylene spark deflector



KCP14956
170 HEADGEAR. Welding Helmet Headgear 170 Air-cushioned cloth sweatband is washable and durable. Teeth are automatically disengaged during adjustment



KCP14967
H-500 Large Lens.W20 H500 Fiberglass Handshields H-500 Large Lens Designed for high-heat applications. Features fiberglass helmet with injection-molded plastic handle. For quick inspections, providing guidance and monitoring robotic welds. Must purchase a filter prior to use



KCP14975
HSL-100 Helmet.W10 HSL 100 Passive Welding Helmets HSL-100 ADF adaptable. Extended front increases throat protection from sparks, slag and other physical hazards. Hard hat adaptable using 187-S (15968).Narrow shell design is perfect for work in tight spaces



KCP14982
HSL-2 Helmet.W10 HSL 2 Passive Welding Helmets HSL-2. Extended front increases throat protection against sparks, slag and other physical hazards. Hard hat adaptable using 187-S (15968).Narrow shell design is perfect for work in tight spaces



KCP15134
HSL-100 Helmet Bulk, 4 1/2 x 5 1/4, Shade 10, Black ADF adaptable. Extended front increases throat protection from sparks, slag and other physical hazards. Hard hat adaptable using 187-S (15968).Narrow shell design is perfect for work in tight spaces



KCP20696
370 Replacement Headgear. Air-cushioned cloth sweatband is washable and durable. Teeth are automatically disengaged during adjustment



KCP21931
Jackson Safety WH40 NITRO* Welding Helmet, Blue Features variable shade 9-13, sensitivity and delay adjustments. Lightweight, offers welders outstanding features at an economical price point. Solar powered, 3 independent sensors



KCP28633
34-60-PC (Flat) Polycarbonate Faceshield 99.9% UV protection. Ideal for impact and heat resistance. Optical-grade polycarbonate from extruded sheets



KCP29052
F30 Acetate Face Shields Clear 8" 99.9% UV protection. High-grade cast sheet acetate protects against splash. Ideal for scratch resistance and premium optics



KCP29056
HU H9194 VISOR15051 99.9% UV protection. High-grade cast sheet acetate protects against splash. Ideal for scratch resistance and premium optics



KCP29077
170-SB Headgear Bulk. HDG20 Face Shield Headgear 170-SB Fully dielectric. Meets ANSI Z87.1 2010 Standards when used with any JACKSON SAFETY* Brand Headgear. Secured with integral plastic lugs. Spark deflector for visor use without a safety cap.



KCP29079
34-40 Acetate 99.9% UV protection. High-grade cast sheet acetate protects against splash. Ideal for scratch resistance and premium optics



KCP36633
Black Nitro Helmet With Nitro ADF Features variable shade 9-13, sensitivity and delay adjustments. Lightweight—only weighs one pound fully assembled. Offers welders outstanding features at an economical price point. Solar powered. Three independent sensors



KCP36680
 WILSON* Back Hand Pad/Glove Protector. 5.5" x 13" Glove protector helps extend glove life and performance. Double-layer protection with WILSON* Aluminum Mylar Aluminum (AMA) top and high-temperature fiberglass bottom. Sewn & riveted for added durability 10/pack (no pack splits)

KCP29090 Dark Green
KCP29091 Clear
 34-42 Acetate.F30 Acetate Face Shields 34-42 Acetate 99.9% UV protection. High-grade cast sheet acetate protects against splash. Ideal for scratch resistance and premium optics

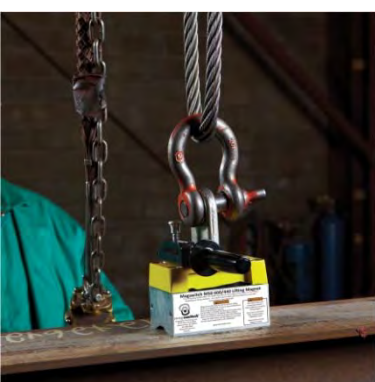

MSW810089
 Magswitch MLAY 600 Lifting Magnet 200 / 90 Single Lifter. Magswitch. The super strong "SINGLE 50mm" is rated at 175 lbs. (3X factor of safety) breakaway on 1/2 inch and thicker flat metal



Magswitch MagSquare Powerful magnetic device that can be turned on and off with a simple half turn of a knob. No batteries. No electricity

Part #	Description
MSW8100099	Magsquare 1000/454 kg
MSW8100106	Magsquare 600/272 kg
MSW8100238	Magsquare 400/181 kg
MSW8100494	Magsquare 165/68 kg



Mini Angles Reduce setup time

- Stays Clean - Longer Life
- More angles in one product
- Stronger grip available in larger sizes
- ON/OFF - When off, metal debris falls away

Part #	Description
MSW8100350	Mini Multi
MSW8100351	Mini Multi w/ 200 Amp Ground
MSW8100352	Mini
MSW8100438	Multi Angle 400



MSW8100359
 Manual Hand Lifters - Ideal for cutting tables, scrap and small steel handling. Manual on/off. Push button on/off cordless electric Hand lifter. Rechargeable batteries. Swivel handle



MSW8100503
 90 Degree Angle 1000. Magswitch 90° welding angle featuring two MagSquare 1000 magnets, each with 1000lb/460kg holding force on each axis. Magswitch 90 degree angles offer unmatched versatility, magnets move up and down or reversible on each axis. Add More MagSquare for additional strength. Holds flat or round steel



MSW8100747
 Magnetic Ground Clamp, 200 lb Capacity, 4" w x 2 7/10" l x 2 3/5" h. Instant ground on flat or pipe. On/Off magnetic clamp enables welder to quickly set up, weld and move on to the next job. Provides strong grip on flat or round surfaces. No more tacking on tabs in large sheet-weld or pipe jobs



MSW8100920
 MagDrill Disruptor 30 utilizes patented shallow-field magnetic technology that offers incredibly strong grip, even on steel as thin as 1/8". Also, the base automatically pivots to conform to any pipe 3" or larger. The magnets do not require electricity, so all the power goes to the motor. This also offers increased safety as the tool will not release from the target material in the event of an unintentional power loss. The magnets can be turned partially on, so the user can fine-tune the exact placement of the cutter head prior to fully engaging the magnets. When the magnets are turned to the "off" position, they are completely off for easy cleanup of steel shavings



MF01-0145-78
Magnaglo® 14AM Prepared Oil Bath, Brown, 16 oz Aerosol Can. Fluorescent prepared bath combines 14A powder with Carrier II oil. Ready-to-use without measuring and mixing. Used to locate fine surface and subsurface discontinuities such as: inclusions, seams, shrink cracks, tears, laps, flakes, welding defects, and grinding, quenching or fatigue cracks



MF01-1580-78
7HF Visible Magnetic Particle Wet Method Prepared Bath, Black, 16oz Aerosol Composed of Magnavis™® 7C Magnaflux magnetic powder suspended in a low volatility mineral oil. Designed for spot inspections of parts that must be inspected in the field due to size or location. Suitable for inspection of tubes, piping and other large structures



MF01-2250-78
Magnavis WCP-2 Contrast Paint, White, 16 oz Aerosol. Can be used with both dry and wet-method magnetic particles. Composed of acetone and inorganic pigments and utilizes a carbon dioxide aerosol propellant for ease of application. Designed for use in applications where the contrast in color between the part being tested and the magnetic particles being used is insufficient for reliable identification of flaws



MF01-1780-69
#8A Red 10 Lb Non-fluorescent Particles General purpose dry method particles. Used on dark surfaces for optimum contrast



MF01-5155-78
Spotcheck SKL-SP2 Solvent Removable Penetrant, Red, 16 oz Aerosol Can. Has been successfully used on non-porous ceramics and other similar materials. Offers maximum reliability in locating surface-open flaws and discontinuities. Solvent removable red color contrast penetrant

MF01-5190-78
Spotcheck SKL-WP2 Water Washable Penetrants, Red, 16 oz Aerosol Can. Eliminates the need for solvent removers or emulsifiers in the elimination of excess surface penetrant. Low odor, water washable penetrant that exhibits outstanding penetrating characteristics and discontinuity identification. Red visible dye. Water wash removable



MF01-5352-78
Skd-S2 Spotcheck® Non-chlorinated Developer A bright white, non-aqueous developer, SKD-S2 creates an opaque white background for high-contrast penetrant testing and quickly draws penetrant out to create stronger, clearer indications for better inspection reliability and sensitivity (16Oz Can) 12/Case
MF01-5352-35
Skd-S2 Spotcheck® Non-chlorinated Developer 1 Gallon, 4/Case

MF01-5750-78
Spotcheck SKC-S, Clear, 16 oz Aerosol Can Non-halogenated. Used in the liquid penetrant inspection process. Used on a moist cloth to remove surface penetrant from the inspection area prior to applying developer





Part #	Description
OET10100011	0811-100 2 Ear Clamp 11Mm (0811) 3/8 100/Bag
OET10100016	Zinc Plated Carbon Steel Sae 1113, 10.8-13.0,.425-.512
OET10100019	2 Ear Clamp 1315 100/Bag
OET10100022	1517-100 2 Ear Clamp 17Mm (1517) 19/32 100/Bag
OET10100024	1518-100 2 Ear Clamp 1518 100/Bag
OET10100027	1720-100 2 Ear Clamp 20Mm (1720) 3/4 100/Bag
OET10100030	2023-100 2 Ear Clamp 23Mm (2023) 7/8 100/Bag



2-Ear design gives increased clamping range. Deburred edges prevents damage to clamped parts. Fast, simple, secure installation. Ideal for air and liquid lines. Robust design for good, permanent sealing



OET14100396
Oetiker Single Action Pincers
Straight jaw single action pincer. Designed for installing and removing ear clamps. Forged steel tool with insulated handle



OET18500106
WK82 Welding Hose Repair Kit



Welding Helmet E684 with Auto Pilot. The new Optrel e684 is the only welding helmet with an ADF lens that fully automates protection through its Adaptive Shade Autopilot technology, automatically adjusting its shade level as the welder works – and in full high definition viewing
OPT1006.500 – Silver
OPT1006.501 – Black
OPT1006.502 – Dark Blue



OPT1006.600
vegaview2.5 auto-darkening helmet offers the BRIGHTEST view possible in light state with Shade Level 2.5 Up to 4 times lighter view in light state and in grind mode



OPT1010.100
Optrel Panoramax Helmet offers an unprecedented visual environment for the welder. A nose cut-out in the auto-darkening filter (ADF) brings the lens closer to the eyes, enlarging the field of view 6 times compared to a standard ADF. Together with a world record light state of 2.5, optrel's True Color view, and the Autopilot feature that fully automates shade level adjustments while you weld, the optrel panoramaxx provides maximum viewing comfort, never seen before in an auto-darkening helmet. Only weighs 550g



TIG TORCH PACKAGES

Part #	Description
PARWP17-12R	WP17 Torch Package X 12.5FT Rubber
PARWP17VFX-12R	WP17VFX Torch Package with Flexi Valve Head X 12.5FT Rubber
PARWP17-25-2	WP17 Torch Package X 25FT 2 Piece
PARWP17FX-25-2	WP17FX Torch Package with Flexi Head X 25FT 2 Piece
PARWP17VFX-25-2	WP17VFX Torch Package with Flexi Valve Head X 25FT 2 Piece
PARWP26-25-2	WP26 Torch Package X 25FT 2 PIECE
PARWP26V-25-2	WP26V Torch Package X 25FT 2 PIECE
PARWP26FX-25R	WP26FX Torch Package X 25FT RUBBER

LINERS

Part #	Description
PAR415-116-15	TRG Steel Liner 200-500A .045IN -1/16IN /1.2-1.6 15FT
PAR42-3035-15	PA NO 1/2 Steel Liner Conduit 0.8-0.9MM X 15FT
PAR44-3545-15	PA NO 3/4/5 Steel Liner, Brass Nipple 0.9-1.2MM X 15FT
PAR44-3545-25	PA NO 3/4/5 Steel Liner, Brass Nipple 0.9-1.2MM X 25FT

*All styles and models are available

*All styles and models are available



GAS LENS BODY

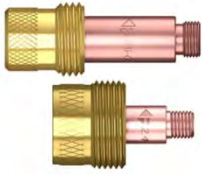

Part #	Description
PAR45V24	WP17/18/26 Gas Lens Body .040IN /1.0MM
PAR45V42	WP9/20/24/25 Gas Lens Body .040IN /1.0MM
PAR45V45	WP9/20/24/25 Gas Lens Body 1/8IN /3.2MM
PAR45V26	WP17/18/26 Gas Lens Body 3/32 / 2.4MM
PAR45V44	WP9/20/24/25 Gas Lens Body 3/32IN /2.4MM
PAR45V116	WP17/18/26 LGE DIA GAS LENS 1/16IN /1.6MM

GAS LENS CUP

*All styles and models are available



Part #	Description
PAR53N58	WP9/20/24/25 Gas Lens Cup 1/4IN /6MM
PAR53N59	WP9/20/24/25 Gas Lens Cup 5/16IN /8MM
PAR53N87	WP9/26 Large Diameter Gas Lens Cup 3/4IN /19MM
PAR53N88	WP9/26 Large Diameter Gas Lens Cup 5/8IN /16MM

CERAMIC CUP

*All styles and models are available



Part #	Description
PAR10N44	WP17/18/26 Ceramic Cup 3/4IN /19MM
PAR10N45	WP17/18/26 Ceramic Cup 5/8IN /16MM
PAR796F74	WP9/26 X Long Ceramic Cup 3/16 IN /5MM
PAR796F75	WP9/26 X Long Ceramic Cup 1/4IN /6MM
PAR796F70	WP9/26 Long Ceramic Cup 3/162/5MM
PAR796F71	WP9/26 Long Ceramic Cup 1/4IN /6MM

COLLET

*All styles and models are available



Part #	Description
PAR13N20	WP9/20/24/25 Standard Collet .020IN /0.5MM
PAR10N22	WP17/18/26 Standard Collet .040IN /1.0MM
PAR13N21	WP9/20/24/25 Standard Collet .040IN /1.0MM
PAR10N23	WP17/18/26 Standard Collet 1/16 /1.6MM
PAR402-3	TRG 200-500A Standard Retaining Head

CONTACT TIPS

*All styles and models are available

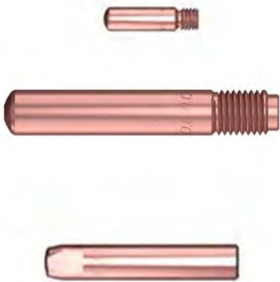

Part #	Description
PAR11-35	PA NO 1 Contact Tip .035IN /0.9MM ECU
PAR14-35	PA NO 2/3/4 Contact Tip .035IN /0.9MM ECU
PAR14-40	PA NO 2/3/4 Contact Tip .040IN /1.0MM ECU
PAR14-45	PA NO 2/3/4 Contact Tip .045IN /1.2MM ECU
PAR1589	PEZH/F-600E Contact Tip .035IN /0.9MM ECU
PAR1590	PEZH/F-600E Contact Tip .045IN /1.2MM ECU
PAR403-116	TRG 200-500A Contact Tip 1/16IN 1.6MM
PAR403-35	TRG 200-500A Contact Tip 0.35IN /0.9MM
PAR403-45	TRG 200-500A Contact Tip .045IN /1.2MM
PAR7489	PEZ G/600W Contact Tip 0.35IN /0.9MM ECU
PAR7490	PEZ G/600W Contact Tip .045IN /1.2MM ECU
PAR7491	PEZ G/600W Contact Tip 1/16IN 1.6MM ECU
PAR403-1-30	TRG 200-500A Contact Tip HD .030IN /0.8MM
PAR403-1-35	TRG 200-500A Contact Tip HD .035IN /0.9MM
PAR403-1-45	TRG 200-500A Contact Tip HD .045IN /1.2MM

NOZZLES

*All styles and models are available



Part #	Description
PAR23-50	PA NO 3 NOZZLE SELF INS 1/2IN /13MM
PAR24CT-62S	PA NO 3/4 Fixed Nozzle Coarse 5/8IN /16MM
PAR34CT	PA NO 2/3/4 Nozzle Insulator Coarse Thread
PAR401-4-50	TRG 200-300A Nozzle 1/8IN RECESS 1/2IN /13MM
PAR401-6-62	TRG 300-500A 5/8 BORE NOZZLE 1/8 RECESS TIP
PAR4391	PEZ 200/300E Brass Nozzle 5/8IN /16MM
PAR4491	PEZ 400/600E Brass Nozzle 3/4IN /19MM

*All styles and models are available



WWW5
Tank Wrench B&MC (Tw-5)



WWWEG-300-B
WWWEG-500-B
Ground Clamps
300Amp or 500Amp



WWWHL-1020-B
Cable Lug Hammer



WWWLGC-300
Ground Clamp Heavy
Duty Copper
WWWLGC-500
Ground Clamp Heavy
Duty Copper



WWN900-MG-8
Mastergauge,
Cam-Type Weld Gage



100-NFG-7
Fillet Weld Gage



WWWMGC-300
Ground Clamp Magnetic



WWWMGC-500
Ground Clamp
Magnetic



WWWPGC-500
Ground Clamp
Copper 500 Amp



WWWSGC-600
Ground Clamp
600 Amp

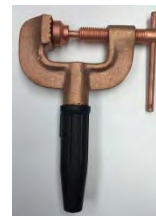

WWWWGC-600
Ground Clamp
600 Amp C



Safetube® rod canisters provide short term consumable storage. Diamond shape prevents unwanted canister rolling off a work surface. The canister cap uses a quick-lock thread for simple removal with just a quarter turn. The cap is also sealed with a pressure fitted O-ring to prevent intrusion of moisture and contaminants



PHX1200201
Type 300 ovens are stationary bench ovens that offer high capacity storage. The oven is powered with two 500W heating elements, which work with the circular shape and door vent to provide a consistent storage environment. Also featured is a thermostat mounted on the rear of the oven, allowing for chamber temperature control. Ideal-sized bench oven for welding and industrial jobsites



PHX1205500
Type 1 Portable Rod Oven
120/240V 10 lb. Removable
locking cord allows easy
replacement. Spring latch
tightly secures an insulated
lid for maximum efficiency



PHX1205510
Type 2 120/240V 20lb.
Dry Rod II Oven.
Removable locking cord
allows easy replacement.
Spring latch tightly
secures an insulated
lid for maximum efficiency



PHX1205520
Type 5 120/240V 50lb. Dry
Rod II Oven. Removable
locking cord allows easy
replacement. Spring latch
tightly secures an insulated
lid for maximum efficiency

Part	Description
PHX1205441	14 inch 10lb Capacity
PHX1205455	18 inch 15lb Capacity



Auto Darkening Helmet

- Superior comfort with pivot style headgear
- Made of high-impact resistant nylon
- Four independent arc sensors in a staggered design to deliver the most reliable arc detection
- High speed lens – 1/30000 second
- Powered by solar cells and replaceable lithium-battery
- Includes magnification lens holder
- Fully adjustable nylon suspension



PYR-WHAM3030GB
Glossy Black



PYRWHAM3030FL
Flames



PYR-WHAM3030FM
Fire Metal Decorated

ROD GUARD

Original & Patented



RODRG-100-24 14 inch
RODRG-200-24 18 inch
 Polyethylene Canisters, Electrode Handled, Blue, 24 per case Features threaded cap with neoprene seal to provide airtight protection for electrodes and other materials.



RODRG-300-12
 Polyethylene Canisters, 36 inch Electrode Handled, Blue Features threaded cap with neoprene seal to provide airtight protection for electrodes and other materials. Great for storage and inventory control of welding electrodes, rods and filler metals. 12/Case

Tempil



Part #	Description
TEMTS0150	28006 Tempilstik 150 Fahrenheit 66 Centigrade
TEMTS0200	28012 Tempilstik 200 Fahrenheit 93 Centigrade
TEMTS0225	28016 Tempilstik 225 Fahrenheit 107 Centigrade
TEMTS0250	28019 Tempilstik 250 Fahrenheit 121 Centigrade
TEMTS0300	28026 Tempilstik 300 Fahrenheit 149 Centigrade
TEMTS0350	28031 Tempilstik 350 Fahrenheit 177 Centigrade
TEMTS0400	28035 Tempilstik 400 Fahrenheit 204 Centigrade
TEMTS0450	28039 Tempilstik 450 Fahrenheit 232 Centigrade
TEMTS0500	28043 Tempilstik 500 Fahrenheit 260 Centigrade

sellstrom



SEL29301
Lift Front Helmet



SEL29311
Silver Lift Front Helmet



SEL29341
Blue Lift Front Helmet



SEL32100
Replacement Window - Clear Anti-Fog



SEL32151
Crown with Holes with Clear Window with Shade



SEL96110
Knee-Pro Knee Pads



TWE1560-1110
 Gas Diffuser (Pk/5)
 Constructed to ensure consistent dimensional stability. Silicon O-ring seals against the nozzle assembly. Use in light to medium duty welding applications



TwecoTong Electrode Holders. Efficient 6 position jaw patterns and fully insulated, protected springs. Reversible top and bottom Insulators

Part #	Model	Amps
TWE9110-1101	A-532	200A
TWE9110-1102	A-316	250A
TWE9110-1103	A-732	300A

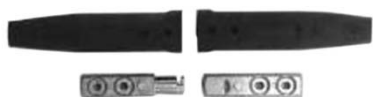

TWE9425-1200
 Complete Connection Equipped with heat- and oil-resistant covers. Provides a positive cam action which optimizes interface between connector halves



TWE1047-1027
 Dinse Style Mechanical Cable Connectors Complete



VIC1000-0263
 FM157 Flowmeter Assembly (Packaged) Flowtube and outer tube are made of impact resistant Lexan for severe applications
 • MIG/TIG applications



VIC0381-1928
 CA 2460 Heavy Duty Cutting Attachment, 8 inch Cut Capacity, 90 Degree Head, Tip



VIC0381-1940
 Victor 400 Series CA411-1, Heavy Duty, Cutting Attachment, Series 1



VIC0384-2101
 Journeyman EDGE 2.0 540/510, 90° Plus Outfit. This heavy duty outfit cuts up to 8" (203.2 mm) and welds up to 3" (76.2 mm) with accessories



VIC0384-2540
 Victor Medalist G250, 540/510, Medium Duty, Cutting System. Built-In Check Valves. One Cutting Attachment for All Fuel Gases



VIC0384-2690
 Victor Medalist G-350, 540/510, Heavy Duty, Cutting System, Medalist 350



WA007022
Weld-Aid
Nozzle Kleen #2
16oz. Protects
nozzles,
diffusers, and
tips. Smoke and
odour free.
Solvent-based,
paintable, and
non-flammable



WA007030
Weld-Aid
Weld Kleen
20oz. Protects
fixtures, parts,
and clamps.
Smoke- and
odour-free.
Solvent-based,
paintable, and
non-flammable



WA007040
Weld-Aid
Lube-matic 5 oz
Cuts rust and
reduces wire
drag 60%. Great
for longer
distance feed.
Helps feed all
mild steel,
fabricated, and
core wires



WA007060
Lube Pad Lubrication
allows smooth feeding of
wires with poor cast,
helix, rust and long feed
liners. Pre-treated with
Lube Matic™ liquid



WA007061
Wire Kleener Pad, Solid, Red
Clean wire and reduce
burnback 50%. Excellent for
aluminum. Reduces wire drag
by 60% and feeds wire more
smoothly



WA007090
Weld-Aid Weld
Kleen 350/1GL
Biodegradable,
non-toxic &
paintable. Can
be frozen.
Economical
and safe



WA007091
Weld-Aid Weld
Kleen 350/5GL
Biodegradable,
non-toxic &
paintable. Can
be frozen.
Economical
and safe



WA007092
Weld-Aid Weld
Kleen 350/55GL
Biodegradable
non-toxic &
paintable. Can be
frozen. Economical
and safe



WAB-100
Brite Zinc is 69% zinc metal. Covers 40
square feet. One step color matches
the shiny look of Hot dip galvanizing.
Special no clog nozzle. Meets ASTM-
A780 for corrosion protection

WESFA-30

Flashback Arrestor Regulator Adaptor Set
10" maximum cutting capacity. Color-coded
for gas service to provide added safety. For
stopping flashbacks by preventing ignition
of mixed gases and to protect equipment
such as hoses, regulators, and cylinders.
Internal check valves designed to prevent
reverse flow and accidental mixing of
oxygen and fuel gases. Torch and regulator
models provide downstream and upstream
protection

WESR125

Ultra Low Cost Balloon Inflator
Hand tight design provides leak-
free connection. Horizontal one-
piece design with all brass
piston construction.
Replaceable rubber tilt valve.
Replaceable Viton™ O-Ring



WESRPB-6HG

Handtight Connection with
Gauge Filtered throughout to
trap foreign matter and extend
regulator life. Heavy duty all
brass piston design.
Replaceable brass quick tie
hook for use with latex balloon
sealing discs. Replaceable
rubber tilt valve for simple,
fast inflation of latex balloons



WESFA-10

Flash Arrestor Torch Style Set
10" maximum cutting capacity.
Color-coded for gas service to
provide added safety. For
stopping flashbacks by preventing
ignition of mixed gases and to
protect equipment. Internal check
valves designed to prevent
reverse flow and accidental
mixing of gases. Torch and
regulator models provide
downstream and upstream
protection

Western's Quick Connects provide fast, reliable and positive
connections and quick disconnections for torches, hoses and
regulators. All models are color-coded for gas service for added
safety (oxygen/green, fuel gas/red, inert gas/blue). Oxy/fuel gas
models include integral reverse flow Check Valves. Quick
Connects fit all B-size welding and cutting equipment.

Quick Connects—sets - B Size (9/16" - 18)

WESQDB10	Torch-to-Hose Set with Check Valves
WESQDB20	Hose-to-Hose Set with Check Valves
WESQDB30	Regulator-to-Hose Set with Check Valves



WESWB-100

Propane Torch, Push Button
Igniter, 500,000 BTU/H Output,
31 in Handle. Ergonomic handle
with adjustable trigger. Flame
tools are for exterior maintenance
and repair. Hooks up to standard
20 lb. propane tank. Hotspotter is
an all-purpose propane torch that
delivers at full cylinder pressure
with no smoke and no fumes.
Push button igniter for fast and
safe lighting



WESWB-101

Hotspotter All Purpose
Propane Torch, 500,000
BTU/H Output, 31 in Handle
Ergonomic handle with
adjustable trigger. Flame
tools are for exterior
maintenance and repair.
Hooks up to standard 20 lb.
propane tank. Hotspotter is
an all-purpose propane torch
that delivers at full cylinder
pressure with no smoke and
no fumes





WES411
Valved Y Connection Inert Gas
RH 5/8"-18 Male



WESQDB33
Q C Socket & Plug/Inert.
Regulator-to-Hose Connect
Brass construction provides
long service life



WESQDB34
Q C Socket & Plug
Hose-to-Machine Connect
Brass construction provides
long service life



WES37
Hose Splicer 1/4
Barb Hex



WESAW-14A
Nut Inert Arc Fitting Can
accommodate up to 200
psi of pressure. Made
from brass to ensure
functionality and durability



WESAW-17
Nipple Inert Arc Fitting.
Can accommodate up
to 200 psi of pressure.
Made from brass to
ensure functionality
and durability



WESAW-430
Coupler-inert Arc
Can accommodate up to 200
psi of pressure. Made from
brass to ensure functionality
and durability



WSC6848-906
36318 Wilson 6'H X 8'W
Black 24oz Fiberglass
Blanket. Approved for use
in vertical applications
with light-moderate
exposures resulting from
chipping, grinding, heat
treating, sand blasting and
light horizontal welding.
Prevents sparks from
escaping a confined area



WSC36336
6FT X 6FT Single Panel Stur-D-Screen
Frame Only. Black powder-coat finish
Includes square steel frame, brackets,
platform "T" legs, lacing ties. Pre-drilled
for caster installation. Square 19-gauge
steel tubing, bolted corner clamps,
platform "T" legs. Stur-D-Screen
available in multiple configurations for a
variety of work environments



WSCUM6500
3019277 6' 6 Inc Dia. Blue
Rip-Stop Umbrella, 36684
6.5' x 7' blue welding umbrella
provides protection from rain
or sunlight. Lightweight
aluminum frame and tilt
mechanism with water and
fire-resistant fabric



WSC36278
Curtain 6x10 Orange PVC
Grommited and ready to hang.
Heavy-duty vinyl designed to filter
far/near ultraviolet radiation and
blue light



WYP1
Standard Tip Cleaner Set 13
Cleaners Size 6 - 2



WYP1100S
Tru Flame Tip Cleaners 111
Cleaners Size 6 - 2



WYP4
King Tip Cleaner Set 13 Cleaners Extra
Long Size



WYP400-1
Flat Soapstone Holder, 3/16" X 5", Stainless
Steel Brass trigger depresses and slides to
proper alignment hole and snaps back to lock
in position. Non-corrosive channel with brass
indexing trigger provides superior sliding
action. Practical design allows for one handed
operation and easy use. Quality construction
for durability and appearance. Spring steel
pocket clip oversized to fit leather aprons



WYP800-1
Round Soapstone Holder, 1/4" X 5", Stainless Steel
Inner sleeve collet securely holds the soapstone
and also adjusts to grip uneven and undersized
soapstone. Locking cap allows accurate
adjustments for closer marking control. Sleek brass
case with contrasting cap and pocket clip enhances
appearance. Slim design provides better visibility in
the marking area

JANITORIAL/SANITATION

BWK-CBOWL946ML-12
HCL Toilet Bowl Cleaner
Ready-to-use 946ml
12/Case

BWK-CFINISH20L-1
High
Traffic Floor Finish
20L 1/Case

BWK-CSTRIP20L-1
Heavy Duty
Floor Stripper 20L

BWK-CGLASS4L-4
Ready-to-Use 4L
4/Case

BWK-CNEUTRAL4L-4
Neutral
Floor Cleaner, Lemon
Scent 4L 4/Case

BWK-CSOAP4L-4
Pink
Lotion Soap 4l
4/Case



English/French
BWKC137112
Safety Sign



BWKC33080
35 Qt Sidepress
Bucket and
Wringer Yellow



BWKC33088
Synthetic Wet
Mop Narrow
Band Cut End
White 24 oz.



BWKC33091
Synthetic Looped
End Wet Mop
Narrow Band Blue
20 oz.



BWKC33095
Cotton Wet
Mop Cut End
24oz.



BWKC33101
Pro-stat Dust
Mop Head
24in. X 5in. Blue
Tie-on



BWKC33105
Snap On Dust
Mop Frame
24in. X 5in.



BWKC33108
Dust Mop 60in.
Metal Handle With
Snap On Clip



BWKC33031
Lobby Dustpan



BWKC34006
Jumbo 15 in. Commercial
Angle Broom



BWKC43325
Microfiber Wet
Pad 18 in.



BWKC44027
4.75"x2.75"x1.375"
Large Erase-It-Sponge
4/Pack



BWKC63252
Urinal Screen With
Non-para Deodorant
Block - Blue Citrus



Part	Description
BWKC2022U-C	Garbage Bags Black 20 X 22 Utility Case 500
BWKC3038S-C	Garbage Bags Clear 30 X 38 Strong Case 200
BWKC3346C-C	Garbage Bags Clear 33 X 46 Contractor Case 40
BWKC3550XS-C	Garbage Bags Clear 35 X 50 X-strong Case 100
BWKC4248S-C	Garbage Bags Clear 42 X 48 Strong Case 125
BWKC3038S-B	Garbage Bags Black 30 X 38 Strong Case 200
BWKC3550XS-B	Garbage Bags Black 35 X 50 X-strong Case 100
BWKC4248S-B	Garbage Bags Black 42 X 48 Strong Case 125
BWKC3346C-B	Garbage Bags Black 33 X 46 Contractor Case 40



BWK-C213000116-20AR
Glass Cleaner is a foaming glass cleaner that cleans and polishes glass without streaking. Combining alcohol, emulsifiers and surfactants, this product gives quick, one step cleaning on all glass and plexiglass surfaces
20 oz 12/Case

BWK-C214000030-20AR
Furniture Polish is a carnauba wax and silicone base cleaner and polish for use on all types of furniture. This product quickly restores original luster to wood and forms a protective coating. It has a pleasant lemon scent that leaves rooms smelling fresh and clean. 20oz 12/Case

BWK-C249000047-20AR
Stainless Steel Polish is an excellent cleaner formulated to clean, brighten, polish and protect stainless steel. It is designed for use in hospitals, offices, hotels, restaurants and institutions
20 oz 12/Case

BWK4781
Bath
Tissue, 2-ply,
4.25" x 3.75",
500 sheets/roll,
48 Rolls/Case
(single wrapped)

BWK4793
Bath
Tissue, 1-ply,
4.25" x 3.66",
1000 Sheets/Roll,
40 Rolls/Case
(single wrapped)



BWK6100
RRT
Bath Tissue,
2-ply, White,
3.5" x 1000'
12 Rolls/Case

BWK6200
Multifold
Towels, White,
16 packages of 250
4000/Case

BWK6202
Multifold
Towels, Natural,
16 packages of 250
4000/Case

JANITORIAL/SANITATION

BWK6212
Singlefold Towels, White, 16 packages of 250, 4000/Case

BWK6210
Singlefold Towels, Natural, 16 packages of 250, 4000/Case



BWK6256
Roll Towels, Natural, 800' per roll 6 Rolls/Case



BWK6400
Center-pull Towels, 2-ply, White, 500'/roll 6 Rolls/Case

BWK6500
Facial Tissue, 2-ply, White, 100 Sheets/Box 30 Boxes/Case



BWKC-P070JPW
P-70 Premium Series Jumbo Roll Wipers White 12x13 870/PK

BWKC-V040CGW
V-40 Value Series GrabBox® Center-Pull DRC Wipers White 10x12 200/PK 1/Case



3MCH-96-6X9
Scotch-Brite™ General Purpose Scouring Pad 96, 6 in x 9 in, 20/box, 3 Box/Case



3MC H-97-6X9
Scotch-Brite™ Hand Pads (Medium Duty) 6in x 9in, 10 Pads/Pack, 10 Packs/Case



3MCH-98-6X9
Scotch-Brite™ Light Duty Cleansing Pad 98, 6 in x 9 in, 20/box, 3 Box/Case



3MCF-4100-WHT-19
3M™ White Super Polish Pad 4100, 19 in, 5/Case



3MCF-7300-WHT-19
3M™ White Super Polish Pad 4100, 19 in, 5/Case



3MCC-10097-21OZ
3M™ Stainless Steel Cleaner and Polish, 21 oz Aerosol, 6/Case



CDS4841
Classique Bath Tissue, 2-ply, 4.25" x 3", 420 sheets/roll 48 Rolls/Case (single wrapped)



CDS1606
Jubilee Roll Towels, Natural, 205'/ roll, 24 Rolls/Case



CDS1616
Jubilee Roll Towels, White, 205'/ roll, 24 Rolls/Case



CLO01169
Clorox Fresh Scent Disinfecting Wipes 75Wipes/Container 6/Case



CLO01537
Clorox Urine Remover 946mL 9/Case



PIN01166
Pine-Sol All Purpose Disinfectant Cleaner 4.25L 3/Case



TIL12438
Tilex Mildew Stain Remover 946 mL 9/Case



FRO101
Universal Roll and Single Fold Dispenser



FRO1195
Hand dryer These compact high speed hand dryers are ideal for renovations and areas with 15amp. circuits available.



FRO301 NL
Medium Waste Receptacle 80 litre, 21 US gal. capacity Rounded edge with swing top design



FRO620
Napkin Disposal



FRO708A
Soap Dispenser All purpose valve vertically mounted liquid soap dispenser. 1.1 litre capacity



315-0955-04
Natural Orange 1 gallon. Quick-acting lotion formula with pumice scrubbing particles for cleaning a broad range of industrial soils, medium dirt and grease. Orange citrus scent.



315-1911-02
GOJO Clear & Mild Foam Handwash. Spa-inspired, green certified foam hand soap offers luxurious foam lather in a fragrance- and dye-free formulation.



315-3770-12-CAN00
12 FL oz. Pump Bottle Purell Advanced Hand Rub



315-6299-02
GOJO® Fast Wipes® Hand Cleaning Towels 225 Count Bucket



315-6396-06
Scrubbing Wipes 72 count



315-9652-12-CAN00
PURELL® Advanced Hand Rub is approved for commercial use, provides persistence against bacteria and kills 99.9% of germs on hands



JANITORIAL/SANITATION



ITWC12532
Spray Nine Grez-Off
Heavy Duty Degreaser
946mL 12/Case



ITWC13532
Spray Nine Industrial
Cleaner/Degreaser
946mL 12/Case



ITWC26804
Spray Nine
Cleaner/Disinfectant
4L Jug 4/Case



ITWC26832
Spray Nine Cleaner/
Disinfectant
946ML Bottle
12/Case



ITWC47946
Spray Nine Orange
Lightning Cleaner/
Degreaser 946ml Bottle
6/Case



ITW20861
Permatex® Fast
Orange Pumice
Lotion Hand Cleaner
378L 4/Case



KCC02000CS
SCOTT® High
Capacity Hard Roll
Towels 950 Ft/Roll
6 Rolls/Case



KCC02001CS
Scott® Essential* High
Capacity Hard Roll
Towels 950 Ft/Roll
6 Rolls/Case



KCC05511CS
Kimtech Science
Precision Wipes
Tissue Wipers
60 Package/Case



KCC05841CS
WYPALL* L30
Wipers
1 Roll/Case



KCC07006CS
SCOTT® Coreless
JRT Jr. Bathroom
Tissue 1150'/Roll
12 Rolls/Case



KCC21400CS
KLEENEX® Facial Tissue
100 Sheets/Box
36 Box/Case



KCC34015CS
WYPALL* X60 Wipers
12.5" x 16.8" 180 sheets
1Box/Case



KCC34790CS
WYPALL* X60 Wipers
126 Sheets/Box
10 Box/Case



KCC41041CS
Wypall X80
Towels Brag Box



KCC47044CS
WYPALL* L20 Wipers in
our Pop-up* box



KCC91371CS
Wypall Waterless
Hand Wipes
75 Wipes/Box,
6/Case



KCC91552CS
KLEENEX® Foam
Skin Cleanser with
Moisturizers 1L
6/Case



PGC07100
Febreze Ae
Linen 275g
9/Case



PGC91544
Dawn Ultra
Original 638ml
10/Case



PGC92815
Swiffer In The
Box Starter Kit



PGC31504
Mr. Clean Liquid
Summer Citrus
Antibacterial 3.78L
3/Case



PGC02621
Mr Clean Finished
Floor Cleaner, Open
Loop 3.78L 3/Case



PGC86084
Cascade All-in-1
Pacs Fresh 72ct
3/Case



PGC00995
Tide Liquid Pods
Original 42 Count
Tub 4/Case



RAC34052
Lysol Disinfectant
Spray Crisp Linen
350G 12/Case



RAC50814
Lysol Toilet Bowl
Cleaner Power
946mL 12/Case



RAC77182
Lysol Wipes Citrus
80ct 6/Case



RAC78909
Lysol All Purpose
Cleaner Pourable
Lemon 1.2L
9/Case



RAC81159
FINISH Powerball
Orange 60CT
4/Case



RAC00394
Easy Off Oven
Cleaner Aerosol
Fume Free 400g
12/Case



RAC41015
Resolve Carpet
High Traffic Foam
623g 12/Case



RCPF131600BLA
Tilt Truck, Heavy-Duty
(Rotational Molded)



RCPF130400BLA
Tilt Truck, Utility Duty
(Rotational Molded)



RCPF262000GRAY
BRUTE® Container
without Lid 20 Gallon



RCPF263200GRAY
BRUTE® Container
32 Gallon



RCPF264000BLA
BRUTE® Dolly for
2620, 2632, 2643,
2655 Containers



RCPF264360GRAY
BRUTE® Container
44 Gallon



JANITORIAL/SANITATION



RCPFG758088YEL
WaveBrake® Side Press Combo 35 Qt



RCPFG757788BRN
WaveBrake® Down Press Combo Brown



RCPFG354007BLUE
Slim Jim® with Venting Channels – Recycling



RCPFG450088BLA
HD 2-Shelf Utility Cart w/Lipped Shelf (Small)



RCPFG617388BLA
Cleaning Cart with Zippered Yellow Vinyl Bag



RCPFG9T5800BLA
Ladder Cart with Cabinet



SCJ-P-F73525
Fantastik Original Disinfectant All Purpose Cleaner 946mL 12/Case



SCJ-P-F73526
Fantastik® Multi-surface Degreaser Disinfectant Sanitizer 4/Case



SCJ-P-W70765
Windex® Glass Cleaner 946mL 12/Case



SCJ-P-W70759
Windex® Glass Cleaner with Ammonia-D® 1 Gal. 4/Case



SCJ-R-O71944
Off!® Deep Woods® Insect Repellent



SCJ-R-R01725
Windex Glass Cleaner 946mL 12/Case



676-2710001213012
Simple Green Concentrate Formula Trigger Spray 709 mL/24 oz. 12/Case



676-2710200613005
Simple Green Concentrate Formula Gallon Bottle 3.78 L/1 gallon Min. 6



676-610000619128
Simple Green Industrial Crystal Gallon Bottle 3.78 L/1 gal. 6/Case



676-610001219024
Simple Green Industrial Crystal Trigger Spray 709 mL /24 oz.12/Case



676-110000413406
Extreme Simple Green Aircraft & Precision Cleaner Gallon Bottle 3.78 L/1 gal. 4/Case



SOF410001
Sofidel Heavenly Soft Single Roll Toilet Tissue 2Ply 500 Sheets 96/Case



SOF410036
Sofidel Heavenly Soft Jumbo Roll Tissue 1 Ply 2000 x3.5 12/Case



SOF410164
Sofidel Heavenly Soft White Multifold Towel White 1Ply 250 Towels/Pack 16/Case



SOF410813
Sofidel Cellysoft 1000 Jumbo Roll Tissue 2 Ply 12/Case



SOF410333
Sofidel Heavenly Soft Dissolve Tech Hardwood Roll Towel 1 Ply 800' 6/Case



UNGEH350
ErgoTec® T-Bar, 14"/35"cm



UNGG350
GoldenClip® Brass Squeegee Complete, 14"/35cm



UNGNA350
ErgoTec® Ninja Window Washer Complete, 14"/35cm



UNGWC350
The Original StripWasher® Strip Pac, 14"/35cm



UNGGH240
Henry's Handi Handle, 2'/60cm



Quality Tools for Smart Cleaning™



UNGPXD7G
StarDuster® ProFlex75



UNGHPNL3 HydroPower Professional 55' Kit Includes:
 HP12C HydroPower™
 UC67G HiFlo™ nLite® HiMod Carbon Master Pole 22'(1)
 UC35G HiFlo™ nLite® HiMod Carbon Poles 11' Extensions(2)
 CT35G HiFlo™ nLite® Carbon Poles 11'Extension(1)
 NLG20 HiFlo™ nLite® Gooseneck
 TMOOV HiFlo™ CONTROL
 NLHPC HiFlo™ nLite® Hose Brush Connection Kits(2)
 NLBJF HiFlo™ nLite® Fan Jets
 NLR27 HiFlo™ nLite® Radius Brush
 NL25G HiFlo™ nLite® Hose
 NLBA1 HiFlo nLite Carrying Bag



UNGSRKT6
Stingray Indoor Cleaning Kit – 10' 1/Case

